

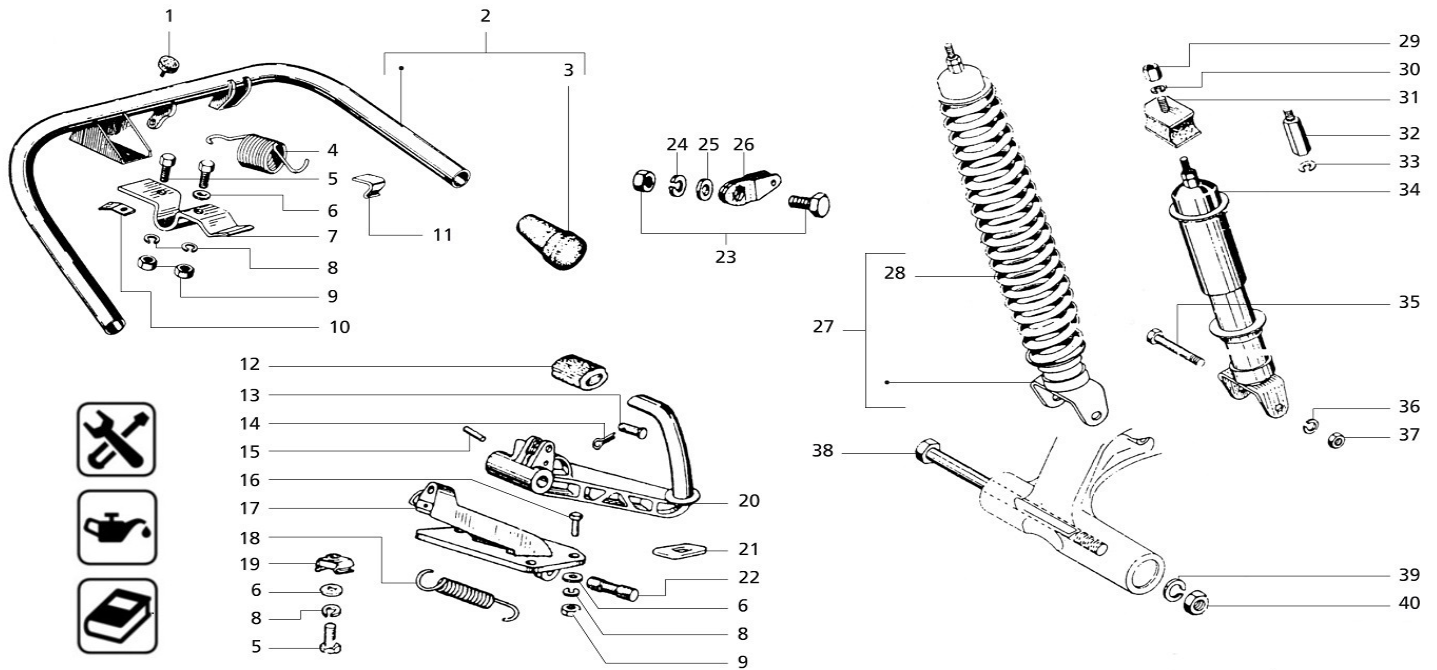



























T_18 Centre Stand, Brake Pedal & Shock Absorber rear























	Prod.no.	Product name	Gross Price
1	17477300	Rubber Buffer centre stand, for Vespa PX/T5 P150S also for LML Star 125- 200 2T /4T w 28 mm, l 28 mm, Ø 22 mm	2,70 EUR
2	52208460	Centre Stand LML Star 125-200 2T/4T, also for Vespa PX80-200 /PE/Lusso/ 98/MY/T5, Ø 22 mm, zinc plated, incl. stand feet, Grade C - low-priced repairs	15,90 EUR
2	75086400	Side Stand SIP 76° for Vespa PK50-125/S/XL/XL2/PX80-200/PE /Lusso/ 98/MY/ 11/T5 l 205 mm, aluminium, red, with 2 springs, automatic return	37,00 EUR
2	75095000	Side Stand for Vespa PX80-200 /PE/Lusso/ 98/MY/T5, chrome, twisted, with one spring	65,00 EUR
2	R121630491	Side Stand RMS for Vespa PX80 -200/PE/Lusso/ 98/MY/T5, chrome, automatic return	35,00 EUR
2	44001000	Centre Stand for Vespa PX80 -200/PE/Lusso/ 98/MY/T5, also for LML Star 125- 200 2T/4T, Ø 22 mm, chrome, with stand feet	24,90 EUR
2	75085000	Side Stand SIP 82° for Vespa PK50-125/S/XL/XL2/PX80-200/PE /Lusso/ 98/MY/ 11/T5 l 245 mm, aluminium, chrome, with 2 springs, automatic return	32,00 EUR

2		44120000	Centre Stand for Vespa PX80 -200/PE/Lusso/ 98/MY/T5, also for LML Star 125- 200 2T/4T, Ø 22 mm, reinforced, chrome, incl. stand feet	29,90 EUR
2		44000000	Centre Stand CIF for Vespa PX80-200/PE/Lusso/ 98/MY/T5, also for LML Star 125- 200 2T /4T, Ø 22 mm, black, incl. stand feet, Grade A - perfect repair	19,90 EUR
2		44002000	Centre Stand for Vespa PX80 -200/PE/Lusso/ 98/MY/T5, also for LML Star 125- 200 2T/4T, Ø 22 mm, stainless steel polished, w/o stand feet	34,90 EUR
2		44070000	Centre Stand for Vespa Cosa/FL 125-200, Ø 22 mm, black, incl. stand feet	25,00 EUR
2		75084400	Side Stand SIP 76° for Vespa PK50-125/S/XL/XL2/PX80-200/PE /Lusso/ 98/MY/ 11/T5 l 205 mm, aluminium, black, with 2 springs, automatic return	35,00 EUR
2		44001500	Centre Stand for Vespa PX80 -200/PE/Lusso/ 98/MY/T5, also for LML Star 125- 200 2T/4T, Ø 22 mm, chrome, twisted, w/o stand boots	75,00 EUR
2		BU4368	Centre Stand BUZZETTI for Vespa PX80-200/PE/Lusso/ 98/MY /T5, also for LML Star 125- 200 2T/4T, reinforced, with jack up facility	35,00 EUR
2		75085400	Side Stand SIP 76° for Vespa PK50-125/S/XL/XL2/PX80-200/PE /Lusso/ 98/MY/ 11/T5 l 205 mm, aluminium, chrome, with 2 springs, automatic return	35,00 EUR
2		75088000	Side Stand SIP 82° for Vespa PK50-125/S/XL/XL2/PX80-200/PE /Lusso/ 98/MY/ 11/T5 l 245 mm, aluminium, red, with 2 springs, automatic return	35,00 EUR
2		75084000	Side Stand SIP 82° for Vespa PK50-125/S/XL/XL2/PX80-200/PE /Lusso/ 98/MY/ 11/T5 l 245 mm, aluminium, black, with 2 springs, automatic return	32,00 EUR
2		44003000	Centre Stand for Vespa PX/PX Lusso/T5, also for LML Star 125- 200 2T/4T, Ø 22 mm, zinc plated, with stand feet	19,90 EUR
2		75081000	Side Stand CUPPINI for Vespa PX80-200/PE/Lusso/ 98/MY/T5, black, with one spring	30,00 EUR









2		44100000	Centre Stand for Vespa PX80 -200/PE/Lusso/ 98/MY/T5, also for LML Star 125- 200 2T/4T, Ø 22 mm, reinforced, black, incl. stand feet	26,90 EUR
3		10572000	Stand Feet for Vespa PK50-125 S/SS/XL/ETS/XL2/ N/FL/Rush /Plurimatic/Automatica/PX80 -200/PE/Lusso/ 98/MY/T5/Cosa also for LML Star 125-200 2T /4T/Deluxe 2T/4S/Speedy /Stella Ø 22 mm, aluminium, silver	15,90 EUR
3		10577000	Stand Feet CUPPINI for Vespa PK50-125 S/SS/XL/ETS/XL2/ N/FL /Rush/Plurimatic/Automatica /PX80-200/PE/Lusso/ 98/MY/T5 /Cosa also for LML Star 125-200 2T /4T/Deluxe 2T/4S/Speedy /Stella Ø 22 mm, chrome, with rubber buffer	24,50 EUR
3		10580000	Stand Feet SIP for Vespa PK50 -125 S/SS/XL/ETS/XL2/ N/FL /Rush/Plurimatic/Automatica /PX80-200/PE/Lusso/ 98/MY/T5 /Cosa also for LML Star 125-200 2T /4T/Deluxe 2T/4S/Speedy /Stella Ø 22 mm, aluminium, silver	22,90 EUR
3		10571000	Stand Feet for Vespa PK50-125 S/SS/XL/ETS/XL2/ N/FL/Rush /Plurimatic/Automatica/PX80 -200/PE/Lusso/ 98/MY/T5/Cosa also for LML Star 125-200 2T /4T/Deluxe 2T/4S/Speedy /Stella Ø 22 mm, aluminium, black	18,90 EUR
3		206115R0	Stand Feet for Vespa PK50-125 S/SS/XL/ETS/XL2/ N/FL/Rush /Plurimatic/Automatica/PX80 -200/PE/Lusso/ 98/MY/T5/Cosa also for LML Star 125-200 2T /4T/Deluxe 2T/4S/Speedy /Stella Ø 22 mm, rubber, red	7,90 EUR
3		52418720	Stand Feet LML for LML Star 125-200 4T/Star Deluxe 125 -150 4S/Speedy also for for Vespa PK50-125 S /SS/XL/ETS/XL2/ N/FL/Rush /Plurimatic/Automatica/PX80 -200/PE/Lusso/ 98/MY/T5/Cosa Ø 22 mm, black, pair Grade C - low-priced repairs	5,90 EUR

3		20611500	Stand Feet for Vespa PK50-125 S/SS/XL/ETS/XL2/ N/FL/Rush /Plurimatic/Automatica/PX80 -200/PE/Lusso/ 98/MY/T5/Cosa also for LML Star 125-200 2T /4T/Deluxe 2T/4S/Speedy /Stella Ø 22 mm, rubber, light grey RAL 7035, as a nice accessory	7,90 EUR
3		20611400	Stand Foot for Vespa PK50-125 S/SS/XL/ETS/XL2/ N/FL/Rush /Plurimatic/Automatica/PX80 -200/PE/Lusso/ 98/MY/T5/Cosa also for LML Star 125-200 2T /4T/Deluxe 2T/4S/Speedy /Stella Ø 22 mm, rubber, black, PIAGGIO, one piece	3,90 EUR
3		J20611410	Stand Feet for Vespa PK50-125 S/SS/XL/ETS/XL2/ N/FL/Rush /Plurimatic/Automatica/PX80 -200/PE/Lusso/ 98/MY/T5/Cosa also for LML Star 125-200 2T /4T/Deluxe 2T/4S/Speedy /Stella Ø 22 mm, rubber, black, PIAGGIO	6,90 EUR
4		16035000	Spring RMS centre stand, for Vespa PX80-200/PE/Lusso/ 98/MY /T5 l 121 mm, Ø 32 mm	3,10 EUR
4		16035300	Spring centre stand, for Vespa PX/PX Lusso T5 also for LML Star 125-200 2T /4T/Deluxe 2T/4S/Speedy /Stella l 112 mm, Ø 17 mm, thin	2,60 EUR
5		18639000	Screw M6x22 mm, 8mm head, brake lever holder, for Vespa PK/S/XL/FL/ HP/N/XL2, brake pedal for Vespa V50/PV /ET3/ PK/PX, rear light for Vespa PK50/S(A /CH/D/ GB)/SS/80/100S/125/S clutch cover PX	0,60 EUR
5		31088000	Screw M6x16 mm, hexagonal, AF 10mm, steel, zinc plated, 8.8, brake cylinder rear, for Vespa Cosa, centre stand for Vespa/LML V50/PV/ET3/PK/ T5/Cosa, brake base plate for Vespa PX/T5 horn PK 125 ETS, luggage hook PK150-125S/Automatica/ETS	0,90 EUR
5		31093000	Screw M6x18 mm, clutch cover, short, for Vespa 50-125/PV/ET3/PK50 -125/S/XL/XL2, centre stand for Vespa V50/PV /ET3/PK/PX, Chain stretcher for Vespa ET4 alter Motor spring seat V50/PV/ET3	1,10 EUR

6		80009000	Washer M6 mm, Ø 6,4x12 mm, (th) 1,6mm, steel, zinc plated, 140 HV	0,20 EUR
7		52418220	Centre Stand Mounting Plate LML for Vespa PX80-200/PE/Lusso/ 98/MY/ 11/T5, also for LML Star 125-200 2T/4T/Deluxe 2T/4S/Speedy/Stella, right, Grade C - low-priced repairs	2,90 EUR
7		12355000	Centre Stand Mounting Plate for Vespa PX80-200/PE/Lusso/ 98/MY/T5, also for LML Star 125-200 2T/4T/Deluxe 2T/4S/Speedy/Stella, Ø 22 mm, 2 pcs, Grade B - decent repair	6,30 EUR
8		80008000	Spring Washer brake arm, M6 mm, Ø 6,1x11,8 mm, (th) 1,6mm, for Vespa PK/S/XL/FL/ HP/N/XL2/PX Lusso/T5 horn for Vespa PK50-125/T5, spring steel, zinc coated, seat lock for Vespa PK50-125S/Automatica/ETS mudguard sideways	0,20 EUR
8		80106000	Locking Washer NORD-LOCK M6 mm, Ø 10,8x6,5 mm, (th) 1,8mm, zinc plated, 2-parts	0,80 EUR
9		17827000	Nut M6 mm, 10, steel, zinc plated, AF 10mm, h 5,0mm	0,20 EUR
9		88840000	Nut M6 mm, 8, steel, zinc plated, AF 10mm, self-locking polyamide wedge	0,30 EUR
9		87302000	Nut M6 mm, Pikenut, chromed	2,30 EUR
9		87300000	Nut M6 mm, Acorn, chromed, AF 10mm	1,70 EUR
9B		90970410	Tool Bag SIP Classic, 640 mm, 270 cm, nylon, black, empty, w/o tools for a first-class repair - grade AA	29,00 EUR
10		17488000	Metal Plate LML centre stand, for Vespa 125 VNA-TS/150 VBA-T4/160GS/180SS/PX/PX Lusso/T5 also for LML Star 125-200 2T/4T/Deluxe 2T/4S/Speedy/Stella for a first-class repair - grade AA	1,20 EUR
10		25855500	Metal Plate centre stand, for Vespa 125 VNA-TS/150 VBA-T4/160GS/180SS/PX/PX Lusso/T5	1,30 EUR

11		77252000	Dies mounting spring main stand, for Vespa V50/PV/ET3 /160GS/180SS/PX/T5 also for LML Star 125-200 2T /4T/Deluxe 2T/4S/Speedy /Stella Grade A - perfect repair	1,00 EUR
12		22879300	Brake Pedal Pad ARIETE for Vespa Cosa 125-200 1/2 black	6,90 EUR
12		86020000	Brake Pedal Pad ARIETE for Vespa 50 R 2°/S 3°/Special V5B3T 2°/90 3°/100 2°/125 PV 3°/ET3 2°/PK50-125/S/XL/XL2 /PX80-200/PE/Lusso/ 98/MY / 11/T5 50x38x24 mm, black, grooved	3,30 EUR
12		86021000	Brake Pedal Pad ARIETE for Vespa 50 R 2°/S 3°/Special V5B3T 2°/90 3°/100 2°/125 PV 3°/ET3 2°/PK50-125/S/XL/XL2 /PX80-200/PE/Lusso/ 98/MY / 11/T5 also for LML Star 125-200 2T /4T/Deluxe 2T/4S/Speedy /Stella 50x38x24 mm, black, fluted	3,70 EUR
12		86021100	Brake Pedal Pad for Vespa 50 R 2°/S 3°/Special V5B3T 2° /90 3°/100 2°/125 PV 3°/ET3 2°/PK50-125/S/XL/XL2/PX80 -200/PE/Lusso/ 98/MY/ 11/T5 also for LML Star 125-200 2T /4T/Deluxe 2T/4S/Speedy /Stella 50x38x24 mm, black, fluted, Grade B - decent repair	3,20 EUR
12		55319760	Brake Pedal Pad LML for Vespa 50 R 2°/S 3°/Special V5B3T 2° /90 3°/100 2°/125 PV 3°/ET3 2°/PK50-125/S/XL/XL2/PX80 -200/PE/Lusso/ 98/MY/ 11/T5 also for LML Star 125-200 2T /4T/Deluxe 2T/4S/Speedy /Stella rubber, black, fluted, economy quality Grade C - low-priced repairs	2,50 EUR
13		71165000	Pin 5,5x21,5 mm, brake calliper, for Vespa V50/PV/ET3/PK/PX/T5, also for LML Star 125-200 2T /4T/Deluxe 2T/4S/Speedy /Stella	1,90 EUR
14		12761000	Cotter Pin pin brake lever, rear, for Vespa V50/PV/ET3/ PK /S/XL/XL2/FL/PX/V1-33/ VM -VB1/VNA-T4/160GS/180SS/ Rally for LML Star 125-200 2T/4T /Deluxe 2T/4S/Speedy/Stella 1x10 mm, steel, zinc plated	0,60 EUR







15		88180000	Pin 3,5x18 mm, brake pedal, for Vespa V50/PV/ET3/PK/PX/ T5, clutch lever for Vespa V50/R/S /Special/ Elestart/Sprinter /SS/V90/SS90/PV/ ET3, brake pedal for LML Star 125 -200 2T/4T/Deluxe 2T/4S /Speedy/Stella	0,90 EUR
16		31091000	Screw M6x22 mm, AF 10mm, mudguard, for Vespa '48-'78,V50/PV/ET3 /PK/PX, brake lever holder for Vespa PK/S/XL/FL/HP/N/XL2, brake pedal for Vespa V50/PV /ET3/PK/PX/LML Star 125-200 2T/4T rear light PK50/S A/CH/D/GB) /SS/ 80/100S/125/S	1,20 EUR
17		55219710	Bracket LML brake pedal, for Vespa V50 R/ S/Special/SR/90 /100/PV/ET3/PK/PX/T5 also for LML Star 125-200 2T /4T/Deluxe 2T/4S/Speedy /Stella Grade C - low-priced repairs	19,90 EUR
17		13874000	Bracket brake pedal, for Vespa V50 R/ S/Special/SR/90/100/PV /ET3/PK/PX/T5 also for LML Star 125-200 2T /4T/Deluxe 2T/4S/Speedy /Stella Grade C - low-priced repairs	29,00 EUR
18		70994000	Spring brake pedal, for Vespa V50/PV/ET3/PK/ PX/T5 also for LML Star 125-200 2T /4T/Deluxe 2T/4S/Speedy /Stella	2,10 EUR
19		50411420	Nut M6 mm, LML, for fitting brake pedal, for Vespa 50-125/PV/ET3/PK 50 -125/PX80- 200 E Lusso/ 98 /MY/'11/T5/LML Star 125-200 2T/4T, voltage regulator for Vespa PK XL/FL/N/XL2 Automatica /Plurimatic, with plate cage Grade C - low-priced repairs	1,00 EUR
19		18287200	Nut M6 mm, for fitting brake pedal, for Vespa 50-125/PV/ET3/PK 50 -125/PX80- 200 E Lusso/ 98 /MY/'11/T5/LML Star 125-200 2T/4T, voltage regulator for Vespa PK XL/FL/N/XL2 Automatica /Plurimatic, with plate cage Grade A - perfect repair	2,00 EUR

20		30031100	Brake Pedal NOTARI for Vespa 50 R 2°/S 3°/Special V5B3T 2° /90 3°/100 2°/125 PV 3°/ET3 2°/PK50-125/S/XL/XL2/PX80 -200/PE/Lusso/ 98/MY/ 11/T5 also for LML Star 125-200 2T /4T/Deluxe 2T/4S/Speedy /Stella w/o base plate Grade A - perfect repair	29,00 EUR
20		55219750	Brake Pedal LML for LML Star 125-200 2T/4T/Deluxe 2T/4S /Speedy/Stella also for Vespa 50 R 2°/S 3° /Special V5B3T 2°/90 3°/100 2°/125 PV 3°/ET3 2°/PK50-125 /S/XL/XL2/PX80-200/PE/Lusso / 98/MY/ 11/T5 Grade C - low-priced repairs	19,90 EUR
20		30036000	Brake Pedal for Vespa 50 R 2° /S 3°/Special V5B3T 2°/90 3° /100 2°/125 PV 3°/ET3 2° /PK50-125/S/XL/XL2/PX80-200 /PE/Lusso/ 98/MY/ 11/T5 also for LML Star 125-200 2T /4T/Deluxe 2T/4S/Speedy /Stella complete (brake pedal/base plate/cable) Grade C - low-priced repairs	42,00 EUR
20		30031000	Brake Pedal PIAGGIO for Vespa 50 R 2°/S 3°/Special V5B3T 2° /90 3°/100 2°/125 PV 3°/ET3 2°/PK50-125/S/XL/XL2/PX80 -200/PE/Lusso/ 98/MY/ 11/T5 also for LML Star 125-200 2T /4T/Deluxe 2T/4S/Speedy /Stella w/o base plate Grade A - perfect repair	39,00 EUR
21		90899000	Gasket brake pedal for Vespa 50 R 2°/S 3°/Special V5B3T 2° /90 3°/100 2°/125 PV 3°/ET3 2°/PK50-125/S/XL/XL2/PX80 -200/PE/Lusso/ 98/MY/ 11/T5 also for LML Star 125-200 2T /4T/Deluxe 2T/4S/Speedy /Stella	1,40 EUR
22		55419700	Bolt LML brake pedal, for Vespa V50/PV/ET3/PK/PX/ T5, also for LML Star 125-200 2T /4T/Deluxe 2T/4S/Speedy /Stella, Grade C - low-priced repairs	6,20 EUR
22		70122100	Bolt brake pedal, for Vespa V50 N/L/R/S/ Special /SR/SS/90/R/SS/100/125/PV /ET3/PX 1°	8,90 EUR
22		18312400	Bolt PIAGGIO brake pedal, for Vespa V50/PV/ET3/PK/PX/T5, also for LML Star 125-200 2T /4T/Deluxe 2T/4S/Speedy /Stella, Grade A - perfect repair	8,90 EUR







23		17726000	Cable Nipple M9 mm, brake cable rear, for Vespa V50/PV/ ET3/PK/S/XL /XL2/FL/ PX/Rally/Sprint	3,40 EUR
23		17726100	Cable Nipple OLYMPIA brake cable rear, for Vespa V50/PV/ET3/PK/S/XL /XL2/FL/PX- Rally, incl. plates	6,00 EUR
24/30		80108000	Locking Washer NORD-LOCK M8 mm, Ø 13,5x8,7 mm, (th) 2,5mm, Type NL8, zinc plated, 2-parts	0,80 EUR
24/30		80005000	Spring Washer M8 mm, Ø 8,1x1.. ..4,8 mm, (th) 2mm, spring steel, zinc coated	0,20 EUR
25		13940000	Washer input shaft, Ø 9,5 mm, for Vespa 125 VM/VN/Hoffmann C /M24/VNA-TS/150 VB1/VL/VGL1 /VD/GS/VBA-Super/160 GS/180 SS/P125-150X 1°/P150S 1° trunnion brake pedal for Vespa V50/PV/ET3/PX 1°	1,90 EUR
26		42047000	Dies brake arm, rear, for Vespa V50/PV/ET3/ /PK/S/XL/XL2 /FL/PX/Rally/Sprint large, w/o hook	1,90 EUR
27		17910800	Shock Absorber rear for Vespa 50-125/PV/ET3/125 VNB4T-TS/150 VBB2T-Super/160 GS 2°/180 SS /Rally/PX80-200/PE/Lusso/'98 /MY/'11/T5, body: black, spr.. ..ing: black, l 335 mm, STANDARD chassis	45,00 EUR
27		70911700	Shock Absorber BITUBO Sport "YZB" rear for Vespa 50-125/PV /ET3/125 VNB4T-TS/150 VBB2T -Super/160 GS 2°/180 SS /Rally/PX80-200/PE/Lusso/'98 /MY/'11/T5, body: red, spring: red, l 335 mm, with TÜV approval, spring pre-load: adjustable, SPORT chassis	155,00 EUR
27		71030000	Shock Absorber CARBONE Sport rear for Vespa 50-125/PV/ET3 /125 VNB4T-TS/150 VBB2T -Super/160 GS 2°/180 SS /Rally/PX80-200/PE/Lusso/'98 /MY/'11/T5, body: red, spring: white, l 345 mm, stiffness: reinforced, spring pre-load: 3 settings, SPORT chassis	58,00 EUR







27		76000RMSB	Shock Absorber SIP PERFORMANCE 2.0 rear for Vespa 50-125/PV/ET3/125 VNB4T-TS/150 VBB2T -Super/160 GS 2°/180 SS /Rally/PX80-200/PE/Lusso/'98 /MY/'11/T5, body: silver matt, spring: black, l 340 mm, stiffness: M, 110 LB, with ABE, KBA 91475, spring pre-load: adjustable, rebound adjustment: 18 settings, aluminium, SPORT chassis	175,00 EUR
27		76001RSB	Shock Absorber SIP PERFORMANCE 2.0 RACE rear for Vespa 50-125 /PV/ET3/125 VNB4T-TS/150 VBB2T-Super/160 GS 2°/180 SS /Rally/PX80-200/PE/Lusso/'98 /MY/'11/T5, body: silver, spring: black, l 340 mm, stiffness: M, 150 LB, compression stroke: 9-times, spring pre-load: adjustable, rebound adjustment: 20 settings, aluminium, external fluid reservoir, RACE chassis	249,00 EUR
27		330025B0	Shock Absorber CARBONE Sport rear for Vespa 50-125/PV/ET3 /125 VNB4T-TS/150 VBB2T -Super/160 GS 2°/180 SS /Rally/PX80-200/PE/Lusso/'98 /MY/'11/T5, body: white, spr.. ..ing: white, seating: thread/fork, spring pre-load: adjustable, SPORT chassis	58,00 EUR
27		330025C0	Shock Absorber CARBONE Sport rear for Vespa 50-125/PV/ET3 /125 VNB4T-TS/150 VBB2T -Super/160 GS 2°/180 SS /Rally/PX80-200/PE/Lusso/'98 /MY/'11/T5, body: black, spr.. ..ing: black, seating: thread/fork, spring pre-load: adjustable, For race use only. Not admitted in the area of the German StVZO", SPORT chassis	58,00 EUR
27		70911500	Shock Absorber BITUBO Racing "YLV" rear for Vespa 50-125/PV/ET3/125 VNB4T-TS/150 VBB2T -Super/160 GS 2°/180 SS /Rally/PX80-200/PE/Lusso/'98 /MY/'11/T5, body: black, spr.. ..ing: red, l 335 mm, with TÜV approval, compression stroke: 12 settings, spring pre-load: adjustable, RACE chassis	230,00 EUR

27		33002400	Shock Absorber CARBONE Stand.. ..ard rear for Vespa 50-125/PV /ET3/SS/125 GT/GTR/Super/TS /150 Super/Sprint/V/180 Rally/PX80-200/PE/Lusso/'98 /MY/T5, body: silver, spring: black, l 340 mm, STANDARD chassis	49,00 EUR
27		33002000	Shock Absorber CARBONE Stand.. ..ard rear for Vespa 50-125/PV /ET3/125 VNB4T-TS/150 VBB2T -Super/160 GS 2°/180 SS /Rally/PX80-200/PE/Lusso/'98 /MY/'11/T5, body: black, seating: thread/fork, w/o spring, STANDARD chassis	37,00 EUR
27		76001RTB	Shock Absorber SIP PERFORMANCE 2.0 RACE rear for Vespa 50-125 /PV/ET3/125 VNB4T-TS/150 VBB2T-Super/160 GS 2°/180 SS /Rally/PX80-200/PE/Lusso/'98 /MY/'11/T5, body: titanium, spring: black, l 340 mm, stiffness: M, 150 LB, compression stroke: 9-times, spring pre-load: adjustable, rebound adjustment: 20 settings, aluminium, external fluid reservoir, RACE chassis	249,00 EUR
27		YSS5043403	Shock Absorber YSS Mono X-Pro Series rear for Vespa 50-125 /PV/ET3/125 VNB4T-TS/150 VBB2T-Super/160 GS 2°/180 SS /Rally/PX80-200/PE/Lusso/'98 /MY/'11/T5, body: black, spr.. ..ing: black, l 340 mm, with ABE, spring pre-load: 5 settings, SPORT chassis	69,00 EUR
27		YSS5043404	Shock Absorber YSS Ecoline rear for Vespa 50-125/PV/ET3 /125 VNB4T-TS/150 VBB2T -Super/160 GS 2°/180 SS /Rally/PX80-200/PE/Lusso/'98 /MY/'11/T5, body: silver, spring: red, l 340 mm, with ABE, spring pre-load: continuously adjustable, external fluid reservoir, RACE chassis	179,00 EUR
27		17910901	Shock Absorber PIAGGIO Stand.. ..ard rear for Vespa PX 2011, also for Vespa 125 VNB 114714 ->/GT-TS/ 150 VBB2T 172370-> /Sprint-Super/ 160 GS/ 180 SS/ Rally/ PX80-200/PE/Lusso /'98/MY/T5 body: black, spri.. ..ng: black, l 380 mm, STANDARD chassis	57,00 EUR









27		76000RBB	Shock Absorber SIP PERFORMANCE 2.0 rear for Vespa 50-125/PV /ET3/125 VNB4T-TS/150 VBB2T -Super/160 GS 2°/180 SS /Rally/PX80-200/PE/Lusso/'98 /MY/'11/T5, body: black, spr.. ..ing: black, l 340 mm, stiffness: M, 110 LB, with ABE, KBA 91475, spring pre-load: adjustable, rebound adjustment: 18 settings, aluminium, SPORT chassis	175,00 EUR
27		76000RMG	Shock Absorber SIP PERFORMANCE 2.0 rear for Vespa 50-125/PV /ET3/125 VNB4T-TS/150 VBB2T -Super/160 GS 2°/180 SS /Rally/PX80-200/PE/Lusso/'98 /MY/'11/T5, body: grey mat, spring: black, l 340 mm, stiffness: M, 110 LB, with ABE, KBA 91475, spring pre-load: adjustable, rebound adjustment: 18 settings, aluminium, SPORT chassis	175,00 EUR
27		RB08135331	Shock Absorber RacingBros BAZOOKA 1.0 rear for Vespa 50-125/PV/ET3/125 VNB4T-TS/150 VBB2T-Super/160 GS 2°/180 SS /Rally/PX80-200/PE/Lusso/'98 /MY/'11/T5, body: black, l 337 mm, spring pre-load: continuously adjustable, rebound adjustment: 18 settings, alu.. ..minium CNC, RACE chassis	289,00 EUR
27		25441002	Shock Absorber PINASCO rear for Vespa 50-125/PV/ET3/ PK50 -125/S/SS/XL/125 GT/GTR /Super/TS/150 Super/Sprint/V /180 Rally/PX80-200/PE/Lusso /'98/MY/T5, body: black/silver, spring: yellow, l 340 mm, seating: thread/lug, spring pre-load: continuously adjustable, SPORT chassis	135,00 EUR
27		33002200	Shock Absorber CARBONE Sport rear for Vespa 50-125/PV/ET3 /125 VNB4T-TS/150 VBB2T -Super/160 GS 2°/180 SS /Rally/PX80-200/PE/Lusso/'98 /MY/'11/T5, body: red, spring: black, seating: thread/fork, SPORT chassis	48,00 EUR
27		YSS50900	Shock Absorber Kit YSS X-Pro Series front & rear for Vespa P80-150X/P200E/PX80-200E/Lusso /'98/MY/'11/T5, body: black, spring: black, l 255/340 mm, spring pre-load: adjustable, with ABE, SPORT chassis	140,00 EUR







27		71016000	Shock Absorber FA Sport rear for Vespa 50-125/PV/ET3/125 VNB4T-TS/150 VBB2T-Super/160 GS 2°/180 SS/Rally/PX80-200 /PE/Lusso/'98/MY/'11/T5, body: black, spring: black, l 325 mm, stiffness: reinforced, spring pre-load: 5 settings, SPORT chassis	52,00 EUR
27		20456028	Shock Absorber RMS rear for Vespa 50-125/PV/ET3/125 VNB4T-TS/150 VBB2T-Super/160 GS 2°/180 SS/Rally/PX80-200/PE /Lusso/'98/MY/'11/T5, body: black, spring: black, l 335 mm, STANDARD chassis	52,00 EUR
27		76000RTB	Shock Absorber SIP PERFORMANCE 2.0 rear for Vespa 50-125/PV /ET3/125 VNB4T-TS/150 VBB2T-Super/160 GS 2°/180 SS /Rally/PX80-200/PE/Lusso/'98 /MY/'11/T5, body: titanium brown, spring: black, l 340 mm, stiffness: M, 110 LB, with ABE, KBA 91475, spring pre-load: adjustable, rebound adjustment: 18 settings, aluminium, RACE chassis	175,00 EUR
27		76000RMB	Shock Absorber SIP PERFORMANCE 2.0 rear for Vespa 50-125/PV /ET3/125 VNB4T-TS/150 VBB2T-Super/160 GS 2°/180 SS /Rally/PX80-200/PE/Lusso/'98 /MY/'11/T5, body: matt black, spring: black, l 340 mm, stiffness: M, 110 LB, with ABE, KBA 91475, spring pre-load: adjustable, rebound adjustment: 18 settings, aluminium, RACE chassis	175,00 EUR
27		76001RSM	Shock Absorber SIP PERFORMANCE 2.0 RACE rear for Vespa 50-125 /PV/ET3/125 VNB4T-TS/150 VBB2T-Super/160 GS 2°/180 SS /Rally/PX80-200/PE/Lusso/'98 /MY/'11/T5, body: silver matt, spring: black, l 340 mm, stiffness: M, 150 LB, compression stroke: 12 settings, spring pre-load: adjustable, rebound adjustment: 20 settings, aluminium, external fluid reservoir, RACE chassis	249,00 EUR

27		70911000	Shock Absorber BITUBO Classic Sport "YZV" rear for Vespa 50-125/PV/ET3/125 VNB4T-TS/150 VBB2T-Super/160 GS 2°/180 SS /Rally/PX80-200/PE/Lusso/'98 /MY/'11/T5, body: red, spring: red, l 335 mm, with TÜV approval, compression stroke: 12 settings, spring pre-load: adjustable, STANDARD chassis	205,00 EUR
27		71017000	Shock Absorber CARBONE Sport rear for Vespa 50-125/PV/ET3 /125 VNB4T-TS/150 VBB2T -Super/160 GS 2°/180 SS /Rally/PX80-200/PE/Lusso/'98 /MY/'11/T5, body: red, spring: black, l 345 mm, stiffness: reinforced, spring pre-load: 3 settings, SPORT chassis	59,00 EUR
27		33002HNO	Shock Absorber CARBONE HiTech rear for Vespa 50-125/PV/ET3 /125 VNB4T-TS/150 VBB2T -Super/160 GS 2°/180 SS /Rally/PX80-200/PE/Lusso/'98 /MY/'11/T5, body: black, spr.. ..ing: black, l 340 mm, SPORT chassis	158,00 EUR
27		76001RBB	Shock Absorber SIP PERFORMANCE 2.0 RACE rear for Vespa 50-125 /PV/ET3/125 VNB4T-TS/150 VBB2T-Super/160 GS 2°/180 SS /Rally/PX80-200/PE/Lusso/'98 /MY/'11/T5, body: black, spr.. ..ing: black, l 340 mm, stiffness: M, 150 LB, compression stroke: 12 settings, spring pre-load: adjustable, rebound adjustment: 20 settings, alu.. ..minium, external fluid reservoir, RACE chassis	249,00 EUR
27		71017037	Shock Absorber Kit CARBONE Sport front & rear for Vespa P80-150X/P200E/PX80-200E/Lusso /'98/MY/'11/T5, body: silver, spring: silver, l 255/345 mm, spring pre-load: 3 settings, SPORT chassis	119,00 EUR
27		71017003	Shock Absorber CARBONE Sport rear for Vespa 50-125/PV/ET3 /125 VNB4T-TS/150 VBB2T -Super/160 GS 2°/180 SS /Rally/PX80-200/PE/Lusso/'98 /MY/'11/T5, body: silver, spring: silver, l 345 mm, stiffness: reinforced, spring pre-load: 3 settings, SPORT chassis	58,00 EUR

27		17910600	Shock Absorber CARBONE Stand.. ..ard rear for Vespa 50-125/PV /ET3/125 VNB4T-TS/150 VBB2T -Super/160 GS 2°/180 SS /Rally/PX80-200/PE/Lusso/'98 /MY/'11/T5, body: phosphated, spring: phosphated, l 340 mm, STANDARD chassis	59,00 EUR
27		33003HN0	Shock Absorber CARBONE HiTech rear for Vespa 50-125/PV/ET3 /125 VNB4T-TS/150 VBB2T -Super/160 GS 2°/180 SS /Rally/PX80-200/PE/Lusso/'98 /MY/'11/T5, body: black, spr.. ..ing: black, seating: thread/fork, SPORT chassis	158,00 EUR
27		33002HR0	Shock Absorber CARBONE HiTech rear for Vespa 50-125/PV/ET3 /125 VNB4T-TS/150 VBB2T -Super/160 GS 2°/180 SS /Rally/PX80-200/PE/Lusso/'98 /MY/'11/T5, body: chrome, spring: red, seating: thread/fork, SPORT chassis	158,00 EUR
27		76001RMB	Shock Absorber SIP PERFORMANCE 2.0 RACE rear for Vespa 50-125 /PV/ET3/125 VNB4T-TS/150 VBB2T-Super/160 GS 2°/180 SS /Rally/PX80-200/PE/Lusso/'98 /MY/'11/T5, body: matt black, spring: black, l 340 mm, stiffness: M, 150 LB, compression stroke: 12 settings, spring pre-load: adjustable, rebound adjustment: 20 settings, alu.. ..minium, external fluid reservoir	249,00 EUR
27		76000RSB	Shock Absorber SIP PERFORMANCE 2.0 rear for Vespa 50-125/PV /ET3/125 VNB4T-TS/150 VBB2T -Super/160 GS 2°/180 SS /Rally/PX80-200/PE/Lusso/'98 /MY/'11/T5, body: silver, spring: black, l 340 mm, stiffness: M, 110 LB, with ABE, KBA 91475, spring pre-load: adjustable, rebound adjustment: 18 settings, aluminium, RACE chassis	175,00 EUR
27		330025D0	Shock Absorber CARBONE Sport rear for Vespa 50-125/PV/ET3 /125 VNB4T-TS/150 VBB2T -Super/160 GS 2°/180 SS /Rally/PX80-200/PE/Lusso/'98 /MY/'11/T5, body: red, spring pre-load: adjustable, SPORT chassis	58,00 EUR















27		33002002	Shock Absorber CIF Standard rear for Vespa 50-125/PV/ET3 /125 VNB4T-TS/150 VBB2T -Super/160 GS 2°/180 SS /Rally/PX80-200/PE/Lusso/'98 /MY/'11/T5, body: phosphated, seating: thread/fork, w/o spring, STANDARD chassis	45,00 EUR
27		33002001	Shock Absorber CARBONE Standard rear for Vespa PX 2011, also for Vespa 125 VNB 114714 ->/GT-TS/ 150 VBB2T 172370-> /Sprint-Super/ 160 GS/ 180 SS/ Rally/ PX80-200/PE/Lusso /'98/MY/T5 body: black, spring: black, seating: thread/fork, w/o spring, STANDARD chassis	48,00 EUR
27		17910700	Shock Absorber CARBONE Standard rear for Vespa 50-125/PV /ET3/125 VNB4T-TS/150 VBB2T -Super/160 GS 2°/180 SS /Rally/PX80-200/PE/Lusso/'98 /MY/'11/T5, body: black, spring: black, l 335 mm, STANDARD chassis	55,00 EUR
28		70080000	Spring Shock Absorber STO shock absorber, rear, for Vespa 50-125/PV/ET3/ PK50-125 /S/SS/XL/ 125 GT/GTR/Super /TS/ 150 Super/Sprint/V/ 180 Rally/ PX80-200/PE/Lusso/'98 /MY/T5 w 58 mm, l 240 mm, zinc coated, stiffness: XXL	32,00 EUR
28		17910900	Spring Shock Absorber rear for Vespa 50-125/PV/ET3/ PK50 -125/S/SS/XL/ 125 GT/GTR /Super/TS/ 150 Super/Sprint /V/ 180 Rally/ PX80-200/PE /Lusso/'98/MY/T5, spring: phosphated, Ø 51/65/51mm, l 235 mm, SPORT chassis	17,90 EUR
28		70074000	Spring Shock Absorber shock absorber, rear, for Vespa 50-125/PV/ET3/ PK50-125/S/SS /XL/ 125 GT/GTR/Super/TS/ 150 Super/Sprint/V/ 180 Rally/ PX80-200/PE/Lusso/'98 /MY/T5 w 57,5 mm, l 240 mm, chromed, hardness: XL	27,60 EUR
28		17910910	Spring Shock Absorber rear for Vespa 50-125/PV/ET3/ PK50 -125/S/SS/XL/ 125 GT/GTR /Super/TS/ 150 Super/Sprint /V/ 180 Rally/ PX80-200/PE /Lusso/'98/MY/T5, spring: phosphated, Ø 51mm, l 235 mm	17,90 EUR















29		20008000	Nut M8x8 mm, shock absorber rear, top, for Vespa V50/PV/ET3/PK/PX /Lusso/VNA-T4/GS160/SS180, mounting single saddle holding for Vespa V50/PV/ET3, engine stud PIAGGIO/GILERA Maxi, engine casing ET4 old engine	0,90 EUR
29		87180000	Nut M8 mm, 8, steel, zinc plated, AF 13mm, h 6,5mm	0,20 EUR
29		87185000	Nut Kit M8 mm, 8, steel, zinc plated, AF 13mm, h 6,5mm, 50 pcs	8,50 EUR
31		60536000	Rubber Buffer rear, top, shock absorber for Vespa 50-125/PV /ET3/ 125 VNA-TS/ 150 VBA-T4 / 160 GS/180 SS/Rally/ PX80 -200/PE/Lusso/ '98/MY/T5 Grade B - decent repair	6,00 EUR
31		60539100	Rubber Buffer CLAUSS STUDIOS rear, top, Shock to Frame Mount for Vespa 125 VNA-TS/150 VBB-Super/160 GS/180 SS /RALLY/PX/PE/Lusso/T5 50-125/PV/ET3 for a better drivability	49,00 EUR
31		60535000	Rubber Buffer PIAGGIO rear, top, shock absorber for Vespa 50-125/PV/ET3/ 125 VNA-TS/ 150 VBA-T4/ 160 GS/180 SS/Rally/ PX80-200/PE/Lusso/ '98/MY/T5 Ø M9 > M8 mm	12,70 EUR
32		14987400	Distance Nut h 55,5mm, Ø M9 mm, shock absorber, rear, for Vespa P80-150X/PX80-200 E /Lusso 1°/P200E, Grade A - perfect repair	4,20 EUR
32		19934400	Distance Nut h 48,0mm, Ø M9 mm, shock absorber, rear, for Vespa PX80-200 E Lusso 2° / '98/MY/T5	5,30 EUR
32		14987100	Distance Nut h 52,5mm, Ø M9 mm, shock absorber, rear, for Vespa P80-150X/PX80-200 E /Lusso 1°/P200E	4,20 EUR
33/36		16410000	Spring Washer screw shock absorber, M9 mm, Ø 9,5x16,3 mm, (th) 2,2mm, for Vespa 50-125/PV/ET3/PK/PX /PX Lusso/T5/VNA-T4/GS160 /SS180 kickstart lever for Vespa 50-125/PV/ET3/PK50-125/S/SS/XL /2, input shaft for Vespa 125 VM /VN/Hoffmann C/M24/VNA/VNB 1°/150 VB1/VL/VGL1/VD/VBA 1° steel, zinc plated, screw carburetor for Vespa 125 VNB -T5/150 VBA-Super/Rally/PX80 -200/PE/Lusso/T5/Cosa	0,70 EUR

33/36		80109000	Locking Washer NORD-LOCK 3/8", ca. M9 mm, Ø 16,6x10,3 mm, (th) 2,5mm, zinc plated, 2-parts	0,90 EUR
34		24662000	Shock Absorber RMS rear for Vespa 50-125/PV/ET3/125 VNB4T-TS/150 VBB2T-Super/160 GS 2°/180 SS/Rally/PX80-200/PE/Lusso/98/MY/11/T5, body: black/silver, w/o spring, STANDARD chassis	29,00 EUR
34		24662400	Shock Absorber rear for Vespa 50-125/PV/ET3/125 VNB4T-TS/150 VBB2T-Super/160 GS 2°/180 SS/Rally/PX80-200/PE/Lusso/98/MY/11/T5, body: chrome, with spring, SPORT chassis	49,00 EUR
35		15594000	Screw M10x65 mm, hexagonal, AF 17mm, steel, zinc plated, 8.8, shock absorber/engine casing, rear, for Vespa PK 50-125 S/SS/PX80-200 E Lusso 2°/98/MY/11/T5, steering head for Vespa 125 VNA/VNB 1-2T, for mirror holder mounting thread: 26mm	2,40 EUR
35		87410000	Screw M9x65 mm, 14mm head, shock absorber/engine casing, for Vespa 50-125/PV/ET3/25 VNA-TS/150 VBA-Super/160 GS/180 SS/Rally/P80-150X/P200E/PX80-200 E Lusso 1°, shock absorber rear for Vespa 125 V1-15T/V30-33T/VM/VN/VU/Hoffmann A/B/C/ACMA/150 VL/VB1/VD/VGL1/GS, incl. circlip/nut	3,70 EUR
35		15595000	Screw M10x75 mm, hexagonal, AF 17mm, steel, zinc plated, 8.8, shock absorber/engine casing, rear, for Vespa PK 50-125 S/SS/PX80-200 E Lusso 2°/98/MY/11/T5, to mount righthand exhaust systems	2,60 EUR
35		87414000	Screw M9x75 mm, hexagonal, AF 14mm, steel, zinc plated, 8.8, shock absorber/engine casing, rear, for Vespa 125 VNA-TS/150 VBA-Super/160 GS/180 SS/Rally/P80-150/200E/Lusso 1°, to mount righthand exhaust systems	11,90 EUR

36		16411000	Spring Washer engine stud, M10 mm, Ø 10,2mm/18,1 mm, (th) 2,2mm, for Vespa 50-125/PV/ET3/PK/S /XL/XL2/Automatica/125 V1-15 /V30T -> 228596 shock absorber front, top for Vespa PK/S/XL/XL2 /Automatica/PX/T5, exhaust for Vespa 50-125/PV /ET3/PX/T5/Cosa spring steel, zinc coated	0,50 EUR
37		20109000	Nut M9 mm, AF 13mm, h 7,0mm, input shaft, for Vespa 125 VNA-TS/150 VBA -Super/160 GS/180 SS/P125 -150X 1°/P150S 1°, shock absorber rear, lower for Vespa V50/PV/ET3/125 VNA-TS/150 VBA-T4/160GS /180SS/Rally/PX/PX Lusso/T5	1,40 EUR
37		20210100	Nut M10 mm, 8.8, AF 17mm, h 6,0mm, shock absorber rear, lower, for Vespa PK 50-125 S/SS/PX80 -200 E Lusso 2°/ 98/MY/ 11 /T5/Cosa/LML 125-200 Star /Deluxe 2T/4T, shock absorber front for Vespa Sprint/Rally	1,90 EUR
37		20210000	Nut M9 mm, AF 14mm, h 4,5mm, input shaft, for Vespa 125 VM/VN/Hoffmann C /M24/150 VB1/VL/VGL1/VD/GS, screw shock absorber, engine casing, spring steering column (lower) for Vespa P125 -150X/P150S	2,20 EUR
37		88540000	Nut M10 mm, 04, steel, zinc plated, AF 17mm, h 5,0mm, clutch, for Vespa 50-125/PV/ET3/PK50 -125/S/XL/XL2, (1), screw shock absorber front /rear for Vespa PX80-200/PE /Lusso/ 98/MY	1,80 EUR
38		87500000	Engine Stud M14x240 mm, hexagonal, FA for Vespa 125 VNA-TS/150 VBA -Super/160 GS/180 SS/Rally /PX80-200/PE/Lusso/T5/Cosa, also for LML Star 125-200 2T /4T/Deluxe 2T/4S/Speedy /Stella, without nut, without circlip, Grade A - perfect repair	9,10 EUR
38		52418710	Engine Stud M14x1,5x235 mm, hexagonal, LML for Vespa 125 VNA-TS/150 VBA -Super/160 GS/180 SS/Rally /PX80-200/PE/Lusso/T5/Cosa, also for LML Star 125-200 2T /4T/Deluxe 2T/4S/Speedy /Stella, Grade C - low-priced repairs	7,10 EUR

39		16414000	Spring Washer engine stud, M14 mm, Ø 14,2mm/24,1 mm, (th) 3mm, for Vespa 125 VNA-TS/150 VBA -Super/160 GS/180 SS/Rally /PX80-200/PE/Lusso/T5/Cosa /50-125/PV/ET3/PK/XL/XL2 also for LML Star 125-200 2T /4T/Deluxe 2T/4S/Speedy /Stella, steel	0,95 EUR
39		80101400	Locking Washer NORD-LOCK M14 mm, Ø 23,0x15,2 mm, (th) 3,4mm, zinc plated, 2-parts	1,70 EUR
40		12640900	Nut M14x1,5 mm, steel, zinc plated, AF 22mm, h 10,5mm, brake drum, front, for Vespa PK50-125/S/SS/XL/XL2 /Automatica/PX80-200E 2° /Lusso/ 98/MY/ 11/T5/Cosa /LML Star 125-200 2T/4T/ Star 125/II/Lite 4T Automatica/CVT, engine stud for Vespa PX/T5	2,00 EUR
40		21214000	Nut M14x1,5 mm, 04, steel, zinc plated, AF 22mm, h 8,0mm, engine stud, for Vespa 125 VNA-TS/150 VBA -Super/160 GS/180 SS/Rally /PX80-200/PE/Lusso/T5/Cosa, also for LML Star 125-200 2T /4T/Deluxe 2T/4S/Speedy /Stella	1,20 EUR
97		98879000	Hand Book "Vespa Tecnica 5" PX 1977/2002, English, limited edition	76,00 EUR
97		610075M0	Instruction Manual PIAGGIO Vespa P125X, P150X, P200E Variante indicatori di direzione, Italian	16,90 EUR
97		610076M0	Instruction Manual PIAGGIO Vespa PX Italian	16,90 EUR
97		610070M0	Instruction Manual PIAGGIO Vespa PX 125 E - PX 150 E - PX 200 E - Arcobaleno 1983, Italian	16,90 EUR
97		98990000	Hand Book HAYNES "Vespa P /PX125, 150 & 200 (incl. LML Star 2-stroke) `78-`12" service & repair manual, English, 138 p.	30,00 EUR
97		98885000	Hand Book "Vespa Tecnica 5" PX 1977/2002, Italian, limited edition	66,00 EUR
97		98880000	Hand Book "Vespa Tecnica 5" PX 1977/2002, German, limited edition	76,00 EUR

97		620013M	Garage Hand Book PIAGGIO Vespa Cosa/FL 125-200cc Italian, 58 p., black/white incl. exploded views, wiring diagram etc.	40,00 EUR
97		99412000	Hand Book Klassische VESPA Motorroller - alle PK, PX, Cosa seit 1970" technics, service, repairs, German, 224 p., 650 colour photos and illustrations, 15th edition	16,90 EUR
97		98920000	Repair Manual "PX/ Cosa" all models 1959-1998 Sprint /Rally, German	39,90 EUR
97		97836170	Hand Book "How to restore Classic Largeframe Vespa Scooters" disc valve, 2-stroke, 1959 - 2008, English, c. 878 illustrations, hardback, ISBN 978-1-845843-24-3	39,00 EUR
98		14235000	Brake Cleaner SIP 500ml, spray	3,90 EUR
98		14131000	Skin Cleaner "Fast Orange", 440ml	7,90 EUR
98		14130000	Skin Cleaner LOCTITE SF 7850, 400ml	12,20 EUR
98		14080000	Multi-Purpose Grease MASTERCARE 400g	4,90 EUR
98		14110000	Hand Cleaner (paste) TEROSON /HENKEL 300g	6,30 EUR
98		14230000	Brake Cleaner MASTERCARE /REPSTAR 500ml, spray	3,50 EUR
99A		15198000	Tool BUZZETTI spring hook hinge/unhinge exhaust spring /bowden cable	8,90 EUR
99A		15193000	Tightener BUZZETTI shock absorber spring span width: 105mm	42,00 EUR
99A		73000500	Tool SIP for shock absorber spring-preload adjustment	9,90 EUR
99B		20837529	Set of Socket Spanners MINI 1/4", chrome-vanadium-steel, 160x8..2x32 mm, plastic case, 23 pieces	42,00 EUR
99B		90980000	Tool Kit for PIAGGIO/Vespa all models flat/phillips headed screwdriver, spark pulg key 21/13, incl. bag	18,90 EUR

99B		20837525	Set of Socket Spanners JMP 1/4" + 1/2", chrome-vanadium-steel, plastic case, 82 parts	149,00 EUR
99B		CR432547	Tool Box 25-piece	19,90 EUR
99B		MXMG05L	Gloves Mechanix The Original, black, unisex, size L, 60% nylon, 35% polyurethan, 5% elastane	29,90 EUR
99B		20837520	Screw Driver Set JMP slotted: 5mm/6mm/8mm, phillips: PH1/PH2/PH3, 6 parts	35,00 EUR
99B		20837516	Torque Key JMP 1/4", 5-25 Nm L=335 mm	70,00 EUR
99B		61627000	Socket Wrench "Mini" 1/4", length grip: 50mm	35,00 EUR
99B		12194000	Knee Pad SIP 435x195x30 mm, foam EVA, black /red	10,20 EUR
99B		20837515	Torque Key JMP 3/8", 20-110 Nm L=403 mm	70,00 EUR
99B		20837522	Combination Wrench Set JMP chrome-vanadium-steel, 6,7,8.. ,9,10,11,12,13,14,17,19,22 mm, 12-parts	57,00 EUR
99B		90982000	Tool Kit wrench 7/8 8/11 regular, phillips screwdriver, spark plug wrench 21/13	15,00 EUR
99B		20837521	Open-End Wrench Set JMP chrome-vanadium-steel, 6/7, 8 /9, 10/11, 12/13, 14/15, 16 /17, 18/19, 20/22 mm, 8-parts	35,00 EUR
99B		20837519	Set of Socket Spanners JMP 1/2", chrome-vanadium-steel, plastic case, 29 parts	99,00 EUR
99B		20837517	Allen Wrench Set JMP 1,5/2/2,5/3/4/5/6/8/10 mm, with ball end, 9 parts	27,00 EUR
99B		20837518	Set of Socket Spanners JMP 1/4", chrome-vanadium-steel, plastic case, 46 parts	85,00 EUR
99B		208462B0	Tool Kit SIP PORDOI, universal, for Vespa all classic 2-stroke models incl. black SIP Classic tool bag, for a first-class repair - grade AA	259,00 EUR
99B		20837523	Pliers Set KNIPEX universal pliers/wire cutter /water pump pliers, 3 parts	75,00 EUR

99B



12194100

Floor Mat SIP 3 in 1
1210x420x30 mm, foam EVA,
black/red,
knee pad, cushion and floor
mat all in one

24,90 EUR