

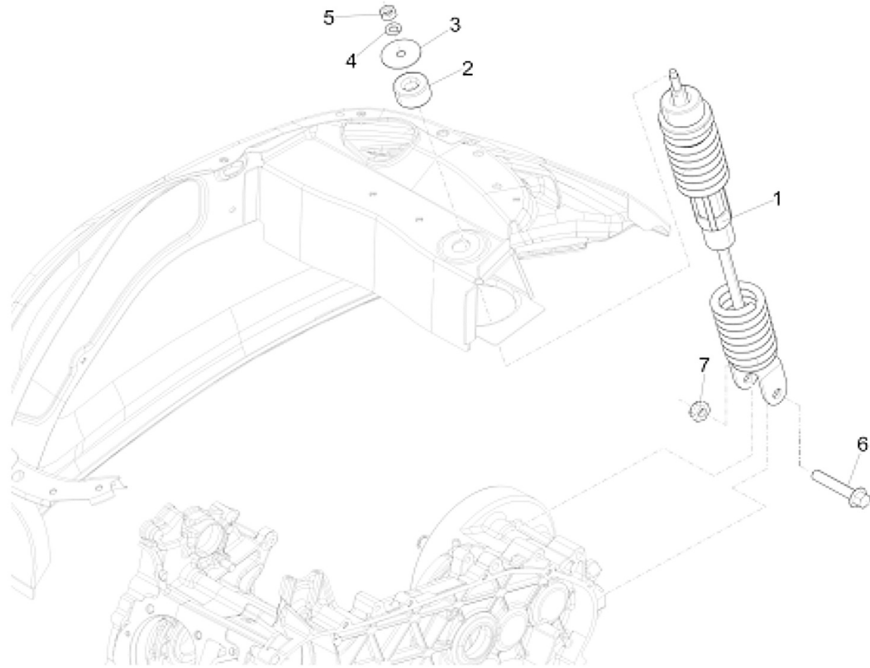







ER41 Chassis Primavera/Sprint - Rear Wheel Suspension - Shock Absorber



		Prod.no.	Product name	Gross Price
1		YSS222365	Shock Absorber YSS DTG rear for Vespa Primavera/Sprint 50ccm 2T/4T, body: black, spring: red, l 365 mm, spring pre-load: adjustable, SPORT chassis - comfortable	65,00 EUR
1		SC217YXB01	Shock Absorber BITUBO YXB rear for Vespa Primavera/Sprint 50ccm 2T/4T, body: black, spring: red/black, spring pre-load: continuously adjustable, SPORT chassis - comfortable	157,00 EUR
1		70124700	Shock Absorber Kit BITUBO front & rear for Vespa Primavera/Sprint 50ccm 2T/4T, body: black, spring: red, spring pre-load: adjustable, SPORT chassis - comfortable	392,00 EUR
1		PI668480	Shock Absorber PIAGGIO rear for Vespa Primavera/Sprint 50ccm 2T/4T, body: black, spring: black, STANDARD chassis - like original	49,00 EUR
2		17815000	Rubber Buffer shock absorber, rear top, upper one, for Vespa PK 50-125/S/XL/XL2 also for Vespa ET2/ET4/LX/LXV /S/Primavera/GTS/GTS Super /GTV/GT 60/GT/GT L/946 50-300ccm	3,90 EUR

3		PI267038	Washer shock absorber, PIAGGIO rear, top, M8x37 mm, for Vespa ET2/ET4/LX/LXV/S /Primavera/Sprint/GTS/GTS Super/GTV/GT 60/GT/GT L/946 50-300ccm also for DERBI/GILERA/PIAGGIO 50-300ccm 2T/4T AC/LC	1,20 EUR
4		80005000	Spring Washer M8 mm, Ø 8,1x1.. ..4,8 mm, (th) 2mm, spring steel, zinc coated	0,20 EUR
5		21108000	Nut M8x1,0 mm, 8, steel, zinc plated, AF 13mm, h 6,5mm, shock absorber, front, top, for Vespa 50-125/PV/ET3/PK50/S /XL (I), (1)	2,10 EUR
6		PI268158	Screw M10x55 mm, PIAGGIO shock absorber rear /engine casing, for Vespa ET2/ET4/LX/LXV/S /Primavera/Sprint/GTS/GTS Super/GTV/GT 60/GT/GT L/946 50-300ccm, also for APRILIA/DERBI/GILERA /PIAGGIO	1,95 EUR
7		87480000	Nut M10 mm, 8, steel, zinc plated, AF 17mm, self-locking screw exhaust, for Vespa PX/T5, (1), polyamide wedge	1,00 EUR
98		14235000	Brake Cleaner SIP 500ml, spray	3,90 EUR
98		14131000	Skin Cleaner "Fast Orange", 440ml	7,90 EUR
98		14130000	Skin Cleaner LOCTITE SF 7850, 400ml	12,20 EUR
98		14110000	Hand Cleaner (paste) TEROSON /HENKEL 300g	6,30 EUR
98		14100000	Thread Locker LOCTITE "243", medium strength, blue, 5ml	10,90 EUR
98		14230000	Brake Cleaner MASTERCARE /REPSTAR 500ml, spray	3,50 EUR
99A		MV599593	Puller Tool suspension arm for Vespa GTS/GTS Super/GTV/GT 60 250-300ccm also for for PIAGGIO Quasar 250-300ccm 4T LC	45,00 EUR
99B		20837525	Set of Socket Spanners JMP 1/4" + 1/2", chrome-vanadium-steel, plastic case, 82 parts	149,00 EUR
99B		MXMG05L	Gloves Mechanix The Original, black, unisex, size L, 60% nylon, 35% polyurethan, 5% elastane	29,90 EUR

99B		12194000	Knee Pad SIP 435x195x30 mm, foam EVA, black /red	10,20 EUR
99B		15199100	Mobile Scooter Hoist for Vespa V50/PV/ET3/PK/VNA -Rally/PX also ET2/ET4/LX/LXV /S/Primavera/Sprint/GTS/GTS Super/GTV/GT 60/GT/GT L 50 -300ccm 2T/4T universal, 360° rotatable, hight min.: 13cm, max, 43cm, net weight: 34kg, load: 400kg	185,00 EUR