

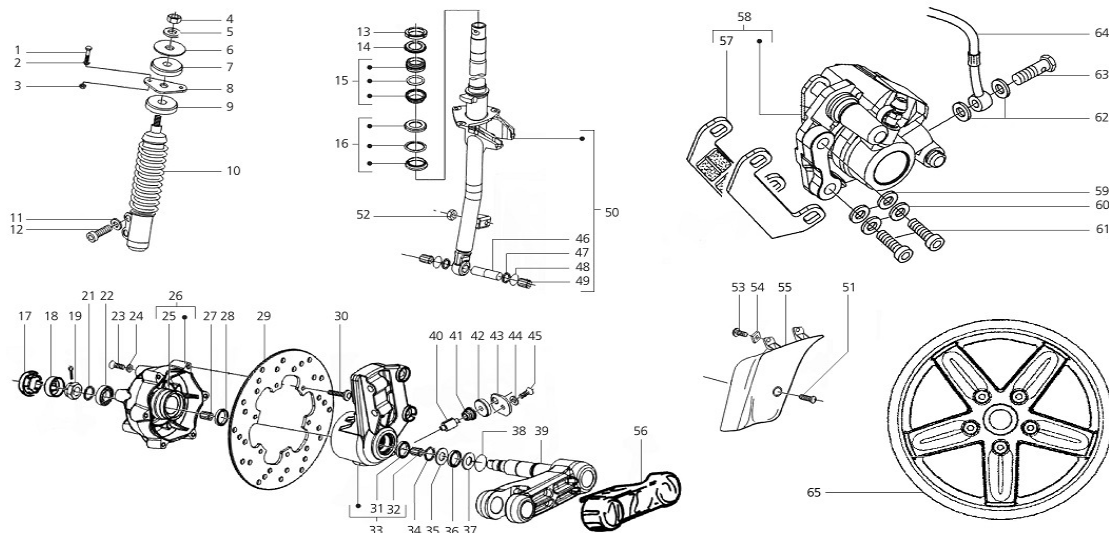















EM84 Steering Column & Brake Drum VESPA ET2/ET4/LX/S front



		Prod.no.	Product name	Gross Price
1		30078000	Screw M8x25 mm, hexagonal, AF 13mm, steel, zinc plated, 8.8	0,60 EUR
2		80005000	Spring Washer M8 mm, Ø 8,1x1.. ..4,8 mm, (th) 2mm, spring steel, zinc coated	0,20 EUR
2		80108J00	Locking Washer Kit NORD-LOCK M8 mm, Type NL8, zinc plated, 10 pair	7,20 EUR
3		PI200800	Nut M8 mm, 8, steel, zinc plated, AF 13mm, self-locking polyamide wedge	0,30 EUR
3		87185000	Nut Kit M8 mm, 8, steel, zinc plated, AF 13mm, h 6,5mm, 50 pcs	8,50 EUR
3/11		87180000	Nut M8 mm, 8, steel, zinc plated, AF 13mm, h 6,5mm	0,20 EUR
4		21210000	Nut M10x1,25 mm, 04, steel, zinc plated, AF 17mm, h 6,0mm, shock absorber, front, top, for Vespa PK/S/XL/XL2 Automatica/PX/T5/ET2/ET4/LX /LXV/S/GT/GTL/GTV/GTS, (1), oil tank outlet for Vespa PX/T5, (1)	1,40 EUR
5		12535000	Lock Washer shock absorber, front, top, Ø i 10,5mm, Ø a 18 mm, for Vespa PK/S/XL/XL2/ Automatica/PX/T5/Cosa/SKR flywheel for Vespa 50 R-S -Special V5B3-90-100/125 PV 2°/ET3/PK50-125 S-PK125 2° /PK50 SS, spring steel, zinc coated	0,70 EUR







6		17408800	Washer shock absorber, front, top, Ø 35x10,5x2 mm, for Vespa PK/S/XL/XL2/Automatica/PX/T5/Cosa	1,40 EUR
7		17408510	Rubber Engine Mounting Bush shock absorber, PIAGGIO front, top, 15,5x32,5x10 mm, for Vespa PX80-200/PE/Lusso / 98/ MY/T5/Cosa 125-150 Elestart/LML Star 125-200 2T /4T/Deluxe 2T/4S/Speedy /Stella for Vespa LX/LXV/S/Primavera /Sprint/GTS/GTS Super/GTV/GT 60/GT/GT L/946 50-300ccm, Grade A - perfect repair	3,20 EUR
7		17408500	Rubber Engine Mounting Bush shock absorber, front, top, for Vespa PX80-200/PE/Lusso / 98/ MY/T5/Cosa 125-150 Elestart/LML Star 125-200 2T /4T/Deluxe 2T/4S/Speedy /Stella for Vespa LX/LXV/S/Primavera /Sprint/GTS/GTS Super/GTV/GT 60/GT/GT L/946 50-300ccm, Grade B - decent repair	2,20 EUR
8		PI273693	Shock Absorber Base Plate PIAGGIO front, for Vespa GTS /GTS Super/GTV/GT 60/GT/GT L 125-300ccm 4T LC for Vespa LX/LXV/S 50-150ccm (-06/2009)	15,70 EUR
8		PI563872	Shock Absorber Seating PIAGGIO front, top, for Vespa ET2/ET4 50-150ccm	14,00 EUR
8		PI601556	Shock Absorber Base Plate PIAGGIO front, for Vespa LX /LXV/S 50-150ccm 06/2009 -> for Vespa 946 3V i.e. 125ccm /GTS/GTS Super 125/300ccm ('14-)	19,90 EUR
9		PI174874	Rubber Buffer PIAGGIO shock absorber, front, bottom, for Vespa LX/LXV/S/Primavera /Sprint/GTS/GTS Super/GTV/GT 60/GT/GT L/946 50-300ccm	2,90 EUR
10		RB1833521	Shock Absorber RacingBros BAZOOKA 3.0 front for Vespa ET2/ET4/LX/LXV/S 50-150ccm, body: black, l 210 mm, compression stroke: 24 settings, spring pre-load: continuously adjustable, rebound adjustment: 18 settings, aluminium CNC, with fluid reservoir, RACE chassis - first-class	369,00 EUR
10		R204584211	Shock Absorber RMS front for Vespa LX/LXV 50-150ccm, body: silver, spring: black, l 247 mm, STANDARD chassis - like original	49,00 EUR







10		22022010	Shock Absorber CARBONE Stand.. ..ard front for Vespa Quartz LC Sfera/Restyling/ET2/2000 /ET4/ Zip SP H2O/LX, for Vespa PK50-125/S/SS/XL/XL2 /Automatica body: black/silver, STANDARD chassis - like original	49,00 EUR
10		PI56351R	Shock Absorber PIAGGIO front for Vespa LXV 50-150ccm, body: silver, spring: chrome, STANDARD chassis - like original	89,00 EUR
10		RB1823521	Shock Absorber RacingBros BAZOOKA 2.0 front for Vespa ET2/ET4/LX/LXV/S 50-150ccm, GTS/GTS Super/Super Sport/GTV /GT 60/GT/GT L 125-300ccm body: black, l 210 mm, spring pre-load: continuously adjustable, rebound adjustment: 18 settings, alu.. ..minium CNC, with fluid reservoir, RACE chassis - first-class	319,00 EUR
10		YSS9042101	Shock Absorber YSS Mono X-Pro Series front for Vespa ET2/ET4 /LX/LXV/S 50-150ccm, for Vespa PK 50-125 S/SS/XL/N/ETS body: black, spring: black, l 210 mm, with ABE, spring pre-load: adjustable, SPORT chassis - comfortable	75,00 EUR
10		PI649458	Shock Absorber PIAGGIO front for Vespa S 50-150ccm, body: silver, spring: red, STANDARD chassis - like original	109,00 EUR
10		PV039GEV01	Shock Absorber BITUBO GAV front for Vespa ET2/ET4 50 -150ccm, body: black, spring: red, l 235 mm, SPORT chassis - comfortable	219,00 EUR
10		RB1843521	Shock Absorber RacingBros BAZOOKA 4.0 front for Vespa ET2/ET4/LX/LXV/S 50-150ccm, also GTS/GTS Super/Super Sport /GTV/GT60/GT/GT L 125-300ccm (*03-`13/ 17-) body: black, l 210 mm, compression stroke: 24 settings High/Low speed, spr.. ing pre-load: continuously adjustable, rebound adjustment: 18 settings, alu.. ..minium CNC, with fluid reservoir, RACE chassis - first-class	489,00 EUR
10		PI56266R	Shock Absorber PIAGGIO front for Vespa LX 50-150ccm, body: silver, spring: black, STANDARD chassis - like original	89,00 EUR

10		PI598922	Shock Absorber PIAGGIO front for Vespa ET2/ET4 50-150ccm, body: silver, spring: black, STANDARD chassis - like original	89,00 EUR
10		PV042GEV01	Shock Absorber BITUBO GEV front for Vespa LX/LXV/S 50-150ccm, body: black, spring: red, adjustable, SPORT chassis - comfortable	225,00 EUR
10		M467900	Shock Absorber MALOSSI RS24 front for PIAGGIO Quartz LC Sfera/Restyling/ET2/2000/ET4 / Zip SP H2O/LX, for Vespa PK50-125/S/SS/XL/XL2 /Automatica body: silver /purple, spring: white, l 205 mm, spring pre-load: adjustable, rebound adjustment: 24 settings, SPORT chassis - comfortable	249,00 EUR
10		22216400	Shock Absorber CARBONE Sport front for Vespa ET2/ET4/LX/LXV /S 50-150ccm, also for PIAGGIO Quartz/SKR body: black, spring: chrome, l 208 mm, seating: thread/fork, stiffness: reinforced, SPORT chassis - comfortable	68,00 EUR
10		222164A0	Shock Absorber CARBONE Sport front for Vespa ET2/ET4 50-150ccm, body: black, spring: red, seating: thread/fork, SPORT chassis - comfortable	68,00 EUR
12/23		14910400	Screw M8x40 mm, inner hexagonal, mirror, for Vespa Cosa FL, shock absorber front, lower (2) for Vespa PX`98/MY/ET2/ET4 /LX/LXV/S/GTS/GTS Super/GTV /GT 60/GT/GT L/946 50-300ccm, wheel stud for Vespa GTS/GTS Super/GTV/GT 60/GT/GT L/946 125-300ccm	1,50 EUR
13		53419020	Nut steering head bearing /column for Vespa 50-125/PV/ET3/PK50 -125/S/SS/XL/125 VM/VN/VNA -TS/150 VL/VB/GS/VBA-T4 /160 GS/180 SS/Rally/PX80-200/PE /Lusso/'98/MY/'11, also for LML Star 125-200 2T /4T/ Star 125/II/Lite 4T Automatica/CVT LML, Grade C - low-priced repairs	2,90 EUR



13		11109000	Nut h 5,2mm, steering head bearing/column, top, for Vespa 50-125/PV/ET3/PK50 -125/S/SS/XL/125 VM/VN/VNA -TS/150 VL/VB/GS/VBA-T4 /160 GS/180 SS/Rally/PX80-200/PE /Lusso/'98/MY/'11, (0), also for LML Star 125-200 2T /4T/ Star 125/II/Lite 4T Automatica/CVT, (0) Grade A - perfect repair	4,90 EUR
14		37510000	Locking Washer steering head bearing, top, Ø 40x30x2,6 mm, for Vespa 50-125/PV/ET3/PK50 -125/S/SS/XL/125 VM/VN/VNA -TS/150 VL/VB/GS/VBA-T4 /160 GS/180 SS/Rally/PX80-200/PE /Lusso/'98/MY/'11 also for LML Star 125-200 2T /4T/ Star 125/II/Lite 4T Automatica/CVT, Grade A - perfect repair	2,90 EUR
15		90102000	Steering Head Bearing Set top for Vespa 50-125/PV/ET3/PK50 -125/S/SS/XL/125 GT-TS/ 150 Sprint/V/Super/160 GS/180 SS /Rally/PX80-200/PE/Lusso/'98 /MY/'11/T5/Cosa, also for GILERA/PIAGGIO 50 -300ccm Automatik PIAGGIO, Ø bearing shell frame top 31x36,55-42,90mm/ Ø ball 4,0 mm, w/o nut steering head/circlip, Grade A - perfect repair	16,50 EUR
15		90100000	Steering Head Bearing Set top for Vespa 50-125/PV/ET3/PK50 -125/S/SS/XL/125 GT-TS/ 150 Sprint/V/Super/160 GS/180 SS /Rally/PX80-200/PE/Lusso/'98 /MY/'11/T5/Cosa, also for GILERA/PIAGGIO 50 -300ccm Automatik Ø bearing shell frame top 31x36,55-42,90mm/ Ø ball 3,2 mm, incl. nut steering head /circlip	16,90 EUR
15/16		90120000	Steering Head Bearing Set upper/lower for Vespa 50-125/PV/ET3/PK50 -125/S/SS/XL/125 GT-TS/ 150 Sprint/V/Super/160 GS/180 SS /Rally/PX80-200/PE/Lusso/'98 /MY/'11/T5/Cosa, also for GILERA/PIAGGIO 50 -300ccm Automatik Ø bearing shell frame top 31x36,55/42,9/ bearing shell frame lower 36,7x64/ bearing shell steering column 35x46,8 mm, w/o dust cover, Grade C - low -priced repairs	22,90 EUR

15/16		90124000	Steering Head Bearing Set upper/lower for Vespa 50-125/PV/ET3/PK50 -125/S/SS/XL/125 GT-TS/ 150 Sprint/V/Super/160 GS/180 SS /Rally/PX80-200/PE/Lusso/'98 /MY/'11/T5/Cosa, also for GILERA/PIAGGIO 50 -300ccm Automatik RMS, Ø bearing shell frame top 31x36,55/42,9/ bearing shell frame lower 36,7x64/ bearing shell steering column 35x46,8 mm, incl. dust cover, Grade B - decent repair	29,00 EUR
16		90115000	Steering Head Bearing Set lower for Vespa 50-125/PV/ET3/PK50 -125/S/SS/XL/125 GT-TS/ 150 Sprint/V/Super/160 GS/180 SS /Rally/PX80-200/PE/Lusso/'98 /MY/'11/T5/Cosa, also for GILERA/PIAGGIO 50 -300ccm Automatik PIAGGIO, Ø bearing shell frame top 31x36,55-42,90mm/ Ø ball 6,35 mm, incl. dust cover, Grade A - perfect repair	17,90 EUR
16		90110000	Steering Head Bearing Set lower for Vespa 50-125/PV/ET3/PK50 -125/S/SS/XL/125 GT-TS/ 150 Sprint/V/Super/160 GS/180 SS /Rally/PX80-200/PE/Lusso/'98 /MY/'11/T5/Cosa, also for GILERA/PIAGGIO 50 -300ccm Automatik Ø bearing shell frame lower 36,7x64/ bearing shell steering column 35x46,8/ dust cover steering column 35x63 mm, incl. dust cover, Grade B - decent repair	15,50 EUR
17		87220000	Hub Nut Cover brake drum, front & rear, for Vespa 50 Special V5B1-4T/SS/90 R/SS /100 2°/125/PV/ET3/125 GT /GTR/TS/150 GL/GS VS5T /Sprint/V/160 GS/180 SS /Rally/P200E 2°/PX80-150 E 2°/Lusso/'98/MY/'11/T5 rear for Vespa 125 VGLA/B/P80 -150X/P200E 1°/PX80-150 E 1° Ø 36 mm, metal, chrome	3,90 EUR
17		87227000	Hub Nut Cover brake drum, front & rear, for Vespa 50 Special V5B1-4T/SS/90 R/SS /100 2°/125/PV/ET3/125 GT /GTR/TS/150 GL/GS VS5T /Sprint/V/160 GS/180 SS /Rally/P200E 2°/PX80-150 E 2°/Lusso/'98/MY/'11/T5 rear for Vespa 125 VGLA/B/P80 -150X/P200E 1°/PX80-150 E 1° Ø 35 mm, plastic, black	4,90 EUR

18		17760900	Locking Washer brake drum, front, for Vespa PK50-125/S/SS /XL/XL2/Automatica/PX80-200E 2°/Lusso/ 98/MY/ 11/T5/Cosa /LML Star 125-200 2T/4T/ Star 125/II/Lite 4T Automatica/CVT brake drum front for Vespa ET2/ET4/LX/LXV/S/Primavera/GTS /GTS Super/GTV/GT 60/GT/GT L /946 50-300ccm Grade A - perfect repair	2,30 EUR
18		53419230	Locking Washer LML brake drum, front, for Vespa PK50-125/S/SS /XL/XL2/Automatica/PX80-200E 2°/Lusso/ 98/MY/ 11/T5/Cosa /LML Star 125-200 2T/4T/ Star 125/II/Lite 4T Automatica/CVT also for Vespa ET2/ET4/LX/LXV /S/Primavera/GTS/GTS Super /GTV/GT 60/GT/GT L/946 50 -300ccm Grade C - low-priced repairs	2,00 EUR
19		12640900	Nut M14x1,5 mm, steel, zinc plated, AF 22mm, h 10,5mm, brake drum, front, for Vespa PK50-125/S/SS/XL/XL2 /Automatica/PX80-200E 2° /Lusso/ 98/MY/ 11/T5/Cosa /LML Star 125-200 2T/4T/ Star 125/II/Lite 4T Automatica/CVT, engine stud for Vespa PX/T5	2,00 EUR
20		87240000	Cotter Pin brake drum, rear, for Vespa 50-125/PV/ET3/PK/XL /XL2/125 VN-TS/150 VL-Super /160 GS/180 SS/Rally/PX80 -200/PE/Lusso/T5/Cosa front for Vespa 50 R 2°-125/PV /ET3/PK50/S/SS/XL/XL2/125 Super 2°/TS/150 GL/VGLA/B /Sprint/V/Super 2°/160 GS /180 SS/Rally/P150S 3,2x50 mm, steel, zinc plated	0,60 EUR
21		66350000	Cluster Circlip P/A front brake drum bearing, for Vespa PK/S/XL/XL2/ PX Lusso/ 98/ T5 /Cosa bearing drive shaft Variator cover for PIAGGIO Leader /Quasar 125-300ccm 4T AC/LC Ø 20 mm	1,30 EUR
22		17761000	Bearing brake drum 20mm for Vespa PK/S/XL/XL2/PX Lusso / 98/T5/Cosa, drive shaft Variator cover for PIAGGIO Leader/Quasar 125-300ccm 4T AC/LC brake drum for LML Star 125 -200 2T/4T/Deluxe 2T/4S /Speedy/Stella SKF, capsuled, 15x35x11 mm, fits also for rear wheel axle HONDA	12,50 EUR











24/60		70904700	Washer brake caliper SKR, M8x15 mm, (th) 1,0mm, for Vespa PX `98/MY also for cover brake master cylinder	0,50 EUR
25		MV669149B	Wheel Hub G-PRO front, for Vespa Primavera/Sprint 125 -150ccm ABS also for PIAGGIO /Vespa ET2/ET4/LX/LXV/S /Hexagon/Sfera RST/ZIP II/SP 50-150ccm, aluminium CNC, black anodised, incl. bearing	169,00 EUR
25		WHL001BK	Wheel Hub OTTOPUNTO front, for Vespa ET2/ET4/LX/LXV/S 50 -150ccm also for PIAGGIO Hexagon/Sfera RST/ZIP II/SP, aluminium CNC, black anodised	159,00 EUR
25		PI267818	Gear Ring PIAGGIO speedometer drive, for Vespa ET2/ET4/LX/LXV/S/GTS /GTS Super/GT/GT L 50-300ccm also for GILERA/PIAGGIO Fuoco /Hexagon/MP3/Quartz/Sfera RST/SKR/ZIP II/SP, 15 teeth	22,70 EUR
26		PI560284	Wheel Hub PIAGGIO front, for Vespa ET2/ET4/LX/LXV/S 50 -150ccm also for PIAGGIO Hexagon/Sfera RST/ZIP II/SP	139,00 EUR
27		17019000	Bearing brake drum inside for Vespa PK/S/XL/XL2/ PX80 -200E/Lusso/`98/MY/T5/Cosa, also for LML Star 125-200 2T /4T/Deluxe 2T/4S/Speedy /Stella 20x26x16 mm, HK2016	9,30 EUR
28		17744300	Oil Seal brake drum inside for Vespa PK/S/XL/ XL2/PX80 -200E/Lusso/`98/MY/T5/ Cosa, also for LML Star 125-200 2T /4T/Deluxe 2T/4S/Speedy /Stella 20x26x4 mm, Grade A - perfect repair	4,60 EUR
28		50411000	Oil Seal brake drum inside for Vespa PK/S/XL/XL2/PX80 -200E/Lusso/`98/MY/T5/Cosa, also for LML Star 125-200 2T /4T/Deluxe 2T/4S/Speedy /Stella LML, Grade C - low-priced repairs	3,20 EUR
29		56324600	Brake Disc PIAGGIO Standard, for Vespa PX 125-200 E `98/MY /`11/ET2/ET4/LX/LXV/S /Primavera/Sprint 50-150ccm /LML Star 125-200 2T/4T, also for GRIMECA Classic NT /PX`98/LML Ø 200/97/4 mm, 5-hole, Grade B - decent repair	39,00 EUR









29		GF650RW	Brake Disc GALFER Wave Extreme, front, for Vespa PX 125-200 E `98/MY/` 11/ET2/ET4/LX/LXV/S /Primavera/Sprint 50-150ccm /LML Star 125-200 2T/4T, also for GRIMECA Classic NT /PX`98/LML Ø 200/97/4 mm, 5-hole, extreme	159,00 EUR
29		R22516016	Brake Disc RMS Standard, for Vespa PX 125-200 E `98/MY/` 11 /ET2/ET4/LX/LXV/S/Primavera /Sprint 50-150ccm/LML Star 125-200 2T/4T, also for GRIMECA Classic NT /PX`98/LML Ø 200/97/4 mm, 5-hole	47,00 EUR
29		GF650W	Brake Disc GALFER WAVE, front, for Vespa PX 125-200 E `98/MY /` 11/ET2/ET4/LX/LXV/S /Primavera/Sprint 50-150ccm /LML Star 125-200 2T/4T, also for GRIMECA Classic NT /PX`98/LML Ø 200/98/4 mm, with KBA, 5-hole	45,00 EUR
29		37214150	Brake Disc LML Standard, for Vespa PX 125-200 E `98/MY/` 11 /ET2/ET4/LX/LXV/S/Primavera /Sprint 50-150ccm/LML Star 125-200 2T/4T, also for GRIMECA Classic NT /PX`98/LML Ø 200/97/3,5 mm, 5-hole, Grade C - low-priced repairs	45,00 EUR
30		47216200	Screw M6x20 mm, inner hexagonal, round head, LML for Vespa PX`98/MY, for Vespa ET2/ET4/LX/LXV/S/GTS /GTS Super/GTS Super Sport /GTV/GT 60/GT/GT L, 50 -300ccm, for LML Star 125-200 2T/4T /Deluxe 2T/4S/Speedy/Stella Grade C - low-priced repairs	0,70 EUR
30		27114700	Screw M6x20 mm, inner hexagonal, round head, brake disc, for Vespa PX`98/MY, for Vespa ET2/ET4/LX/LXV/S/GTS /GTS Super/GTS Super Sport /GTV/GT 60/GT/GT L, 50 -300ccm, also for LML Star 125-200 2T /4T/Deluxe 2T/4S/Speedy /Stella with screw locking, for a first-class repair - grade AA	0,90 EUR















31		50411020	Oil Seal brake base plate 20mm front for Vespa PK/S/XL/XL2/PX/Lusso /'98, for LML Star 125-200 2T/4T /Deluxe 2T/4S/Speedy/Stella LML, 46x56x4 mm, metal Grade C - low-priced repairs	4,50 EUR
31		17749400	Oil Seal brake base plate 20mm front for Vespa PK/S/XL/XL2/PX/Lusso /'98, for LML Star 125-200 2T/4T /Deluxe 2T/4S/Speedy/Stella 46x56x4 mm, Grade A - perfect repair	5,30 EUR
32		17744200	Bearing brake base plate 20mm front for Vespa PK/S/XL/XL2/PX80 -200E/Lusso/'98/MY/T5/Cosa, RMS, 22x28x12 mm	7,10 EUR
33		P0502252	Axle Seating POLINI brake calliper/shock absorber front, for Vespa ET2/ET4/LX /LXV/S 50-150ccm also for PIAGGIO Sfera RST/ZIP II/ZIP SP 50-125ccm blue, for a better drivability	119,00 EUR
33		PI560286	Axle Seating PIAGGIO brake calliper/shock absorber front, for Vespa ET2/ET4/LX /LXV/S 50-150ccm also for PIAGGIO Sfera RST/ZIP II/ZIP SP 50-125ccm	105,00 EUR
34		50411240	Cluster Circlip LML brake base plate, for Vespa PK/S/XL/XL2 /PX80-200E/Lusso/'98/MY/T5 /Cosa for LML Star 125-200 2T/4T /Deluxe 2T/4S/Speedy/Stella Ø 20 mm, Grade C - low-priced repairs	1,10 EUR
34		64220000	Cluster Circlip brake base plate, inner, for Vespa PK/S /XL/XL2/PX80-200E/Lusso/'98 /MY/T5/Cosa for LML Star 125-200 2T/4T /Deluxe 2T/4S/Speedy/Stella Ø 20 mm, for a first-class repair - grade AA	1,80 EUR
35		17741400	Spacer brake base plate 20mm, front, for Vespa PK/S/XL/XL2/PX80 -200E/Lusso/'98/MY/T5 for LML Star 125-200 2T/4T /Deluxe 2T/4S/Speedy/Stella, for a first-class repair - grade AA	1,50 EUR
35		53419130	Spacer brake base plate 20mm, LML front, for Vespa PK/S/XL/XL2/PX80 -200E/Lusso/'98/MY/T5 for LML Star 125-200 2T/4T /Deluxe 2T/4S/Speedy/Stella, Grade C - low-priced repairs	1,20 EUR







36		17752100	Sealing Ring axle seating 20mm for Vespa PK/S/XL/XL2/PX Lusso /T5/Cosa for LML Star 125-200 2T/4T /Deluxe 2T/4S/Speedy/Stella 21-27-4 V-lip Grade A - perfect repair	1,50 EUR
36		50411030	Sealing Ring axle seating 20mm front for Vespa PK/S/XL/XL2/PX Lusso /T5/Cosa, for LML Star 125-200 2T/4T /Deluxe 2T/4S/Speedy/Stella LML, 21-28-4 V-lip, Grade C - low -priced repairs	1,00 EUR
37		17744500	Spacer axle seating, front, Ø 36,5x22 mm, for Vespa PK/S/ XL/XL2/PX80 -200E/Lusso/ 98/MY/T5 also for LML Star 125-200 2T /4T/Deluxe 2T/4S/Speedy /Stella, Grade A - perfect repair	1,80 EUR
38		17740800	O-Ring axle seating, PIAGGIO front, Ø 38 mm, (th) 1,7mm, for Vespa PK/S/XL/XL2/PX Lusso /T5/Cosa also for LML Star 125-200 2T /4T/ Star 125/II/Lite 4T Automatica/CVT, Grade A - perfect repair	1,40 EUR
38		50410990	O-Ring axle seating, LML front, Ø 38 mm, (th) 1,9mm, for LML Star 125-200 2T/4T/ Star 125/II/Lite 4T Automatica/CVT also for Vespa PK/S/XL/XL2/PK Lusso/T5/Cosa, Grade C - low-priced repairs	0,80 EUR
39		PI648397	Swing Arm PIAGGIO front, for Vespa ET2/ET4/LX/LXV/S/946 /GTS/GTS Super/GTV/GT 60/GT /GT L 50-300ccm 2T/4T for PIAGGIO Hexagon/MP3 Yourban /Sfera RST/ZIP	52,00 EUR
40		PI267819	Speedometer Drive Gear for PIAGGIO/Vespa Hexagon/Quartz /Sfera RST/SKR/ZIP II/SP/ET2 /ET4/LX/LXV/S/GTS/GTS Super /GT/GT L 50-300ccm 12 teeth	4,90 EUR
41		56405300	Gear Guide speedometer drive gear, for Vespa PX `98/MY also for Vespa ET2/ET4/LX/LXV /S/GTS/GTS Super/GTV/GT 60 /GT/GT L, 50-300ccm	4,00 EUR
42		PI266841	Rubber passage speedometer drive, for PIAGGIO/Vespa Hexagon /Quartz/Sfera RST/SKR/ZIP II /SP/ET2/ET4/LX/LXV/S/GTS/GTS Super/GTV/GT 60/GT/GT L 50 -300ccm	1,40 EUR







43		PI269118	Washer mounting speedometer cable, for PIAGGIO/Vespa Hexagon /Quartz/Sfera RST/SKR/ZIP II /SP/ET2/ET4/LX/LXV/S/GTS/GTS Super/GTV/GT 60/GT/GT L 50 -300ccm	1,60 EUR
45		21056000	Screw M5x12 mm, hexagonal, AF 8mm, steel, zinc plated, 8.8, mounting speedometer cable, for Vespa V50/PV/ET3/PK/PX/T5 /Cosa, (1), base plate cable lever for Vespa 50/N/L/R/S/SR/90/R/125 /PV/GT/GTR/Super/150 GL /Sprint/Veloce/ Super/180 Rally/SS/200 Rally, rear light for Vespa PK50/S(I)	0,90 EUR
46		17745200	Rocker Bearing Bolt for Vespa PK50-125/S/SS/XL/XL2/P150X 346431->/PX125 1116->/P200E 112625->/PX100/PX80-200E Lusso/98/MY/11/T5/Cosa also for PIAGGIO 50 Sfera /Quartz/125 SKR/Hexagon 20 mm, Ø stud 16mm, Ø bearing 22mm	7,90 EUR
47		11921900	Sealing Ring suspension bolt 20mm (outside) for Vespa PK/S /XL/ XL2/PX80-200E/Lusso/98 /MY/T5	1,60 EUR
48		67310000	Sealing Ring suspension bolt 20mm (inside) for Vespa PK/S /XL/ XL2/PX80-200E/Lusso/98 /MY/T5 31x25x4mm	1,90 EUR
49		19851300	Bearing suspension arm for Vespa PK/S/XL/XL2/ PX80 -200E/Lusso/98/MY/T5/ Cosa	7,90 EUR
50		PI600959	Steering Column PIAGGIO for Vespa ET2/ET4 50-150cc, incl. suspension arm	215,00 EUR
50		PI6484135	Steering Column PIAGGIO for Vespa LX/LXV/S 06/2009 -> 50-150cc, incl. suspension arm	217,00 EUR
51/53		PI575249	Screw M6x16 mm, cover, with collar, black	1,00 EUR
52		17827000	Nut M6 mm, 10, steel, zinc plated, AF 10mm, h 5,0mm	0,20 EUR
54		PI254485	Clip cover automatic scooter, speed nut M6	0,80 EUR
55		PI6004164	Fork Cover PIAGGIO for Vespa LX/LXV 50-150ccm uncoated, plastic	47,00 EUR
55		PI654268	Fork Cover PIAGGIO for Vespa S 50-150ccm black	11,70 EUR
55		MV400057	Fork Cover SIP for Vespa LX/LXV 50-150ccm chrome, plastic	31,90 EUR

56		ZELFC00C	Suspension Arm Cover aluminium CNC, chrome, ZELIONI for Vespa ET2/ET4/LX/LXV/S/GTS /GTS Super/GTV/GT 60/GT/GT L 50-300 (03-13/17-), also for Vespa Primavera /Sprint (17-)	69,00 EUR
56		PI650264	Suspension Arm Cover PIAGGIO for Vespa ET2/ET4/LX/LXV/S/GTS /GTS Super/GTV/GT 60/GT/GT L 50-300 (03-13/17-) plastic, silver matt, also for Vespa Primavera /Sprint (17-), with "Vespa" badge	23,90 EUR
56		65026100	Cooling Hood disc brake, CRI.. ..MAZ for Vespa ET2/ET4/LX/LXV/S/GTS /GTS Super/GTV/GT 60/GT/GT L 50-300ccm also for PIAGGIO ZIP/SFERA/SKR, plastic, primed, incl. cooling for disc brake	40,00 EUR
56		ZELFC00B	Suspension Arm Cover aluminium CNC, black, ZELIONI for Vespa ET2/ET4/LX/LXV/S/GTS /GTS Super/GTV/GT 60/GT/GT L 50-300 (03-13/17-), also for Vespa Primavera /Sprint (17-)	79,00 EUR
56		MV400033	Suspension Arm Cover SIP for Vespa ET2/ET4/LX/LXV/S/GTS/GTS Super/GTV/GT 60/GT/GT L 50-300 (03-13/17-) plastic, chrome, also for Vespa Primavera /Sprint (17-), "Old Style"	19,00 EUR
56		PI561433	Suspension Arm Cover PIAGGIO for Vespa ET2/ET4/LX/LXV/S/GTS /GTS Super/GTV/GT 60/GT/GT L 50-300 (03-13/17-) plastic, chrome, also for Vespa Primavera /Sprint (17-)	11,90 EUR
56		PI561433B	Suspension Arm Cover PIAGGIO for Vespa ET2/ET4/LX/LXV/S/GTS /GTS Super/GTV/GT 60/GT/GT L 50-300 (03-13/17-) plastic, black, also for Vespa Primavera /Sprint (17-)	29,90 EUR
57		PI647157	Brake Pads PIAGGIO S14, for HENG TONG brake calliper, front left/right, for GILERA /PIAGGIO FUOCO 500ccm/MP3 125-500ccm, 49x35x7,0 mm	16,90 EUR
57		GF1454	Brake Pads GALFER SPORT S14, 49x35x7,0 mm with e-pass	13,50 EUR
57		R22510030	Brake Pads RMS S14, 49x35x7,0 mm with e-pass	10,90 EUR

58		MV564230	Brake Calliper SIP front, for Vespa LX/LXV/S/ 50-150/125 Primavera 3V (Vietnam Modell), black, Ø 31,5 mm, with e-pass, KBA 61372	105,00 EUR
58		MV564260	Brake Calliper SIP front, for Vespa LX/LXV/S/ 50-150/125 Primavera 3V (Vietnam Modell), gold, Ø 31,5 mm, with e-pass, KBA 61372	109,00 EUR
58		MV564240	Brake Calliper SIP front, for Vespa LX/LXV/S/ 50-150/125 Primavera 3V (Vietnam Modell), red, Ø 31,5 mm, with e-pass, KBA 61372	105,00 EUR
58		P0502238	Brake Calliper POLINI front, for Vespa ET2/ET4/LX/LXV/S 50 -150ccm also for PIAGGIO Lib.. ..erty/ZIP II/ZIP SP 50-150ccm, Ø 32 mm, aluminium CNC, 2 pistons	249,00 EUR
58		GR362410	Brake Calliper PIAGGIO front, HENG TONG for Vespa ET2/ET4/LX/LXV/S 50 -150/PIAGGIO Liberty/ZIP II /FR/SP 50-200ccm fits also in connection with conversion steering column SIP PIAGGIO ZIP SP for Vespa 50-125/PV/ET3 /PK50-125/S/SS/XL/Automatica /125 VNA-TS/150 VBA-Super /Rally, Ø 30 mm, black anodised	77,00 EUR
58		MV564210	Brake Calliper SIP front, for Vespa LX/LXV/S/ 50-150/125 Primavera 3V (Vietnam Modell), silver, Ø 31,5 mm, with e-pass, KBA 61372	109,00 EUR
58		MV564250	Brake Calliper SIP front, for Vespa LX/LXV/S/ 50-150/125 Primavera 3V (Vietnam Modell), titanium, Ø 31,5 mm, with e-pass, KBA 61372	109,00 EUR
59		56649000	Washer screw spare wheel cover, Ø 15x8,5x1,6 mm, for Vespa PX/T5/Cosa/Rally/TS handle bar lever brake/choke for Vespa PKXL FL/HP/N/XL2 /Automatica, starter for LML Star 125-200 2T/4T/Deluxe 2T/4S/Speedy /Stella	0,95 EUR

61		27159600	Screw M8x25 mm, inner hexagonal, cylinder head, AF 6mm, steel, zinc plated, 8.8, brake caliper, for Vespa ET 2/ET 4/LT/LX/LXV /PX/S/Primavera/Sprint/GTS /GTS Super/GTV/946 50 /300ccm, brake master cylinder for Vespa PX`98/MY	1,00 EUR
62		90240000	Sealing Ring (th) 1,5mm, hydraulic aluminium, Ø 10,2x15 mm	0,60 EUR
63		90210000	Banjo Bolt M10x1 mm, 18mm, for `98 pressure transducer	8,90 EUR
63		9021C000	Banjo Bolt M10x1 mm, aluminium, chrome anodized, SPIEGLER	4,90 EUR
63		90213100	Banjo Bolt M10x1 mm, stainless steel, SPIEGLER with breather nipple	19,90 EUR
64		MV649871	Brake Hose SPIEGLER front, for Vespa LX/S 50-150ccm, transparent, chrome, l 1150 mm, braided steel, straight, 90°	59,00 EUR
64		SP3601077	Brake Hose SPIEGLER front, for Vespa ET2/ET4 50-150ccm, transparent, l 1140 mm, 90°, 20°, with TÜV approval	85,00 EUR
64		PI649871	Brake Hose PIAGGIO front, for Vespa S 50-150ccm	55,00 EUR
64		PI646893	Brake Hose PIAGGIO front, for Vespa LX, 50-100cc, 2/4 stroke	67,00 EUR
65		GR67106S	Rim front for Vespa ET2/ET4 50-150ccm, 2.50-10", silver	159,00 EUR
65		PI6672525	Rim front PIAGGIO for Vespa S 50-150ccm Sport, also for Vespa LX/LXV 50-150ccm, 2.50-11", black with silver edge	82,00 EUR
65		GR67102S	Rim front PIAGGIO for Vespa LX/LXV/S 50-150ccm, 2.50-11", silver	85,00 EUR
65		PI58624R	Rim front PIAGGIO for Vespa S 50-150ccm Facelift, also for Vespa LX/LXV 50-150ccm, 2.50-11", matt black	75,00 EUR
97		99423000	Hand Book PIAGGIO/VEPSA Sfera /Typhoon/ZIP/Fly/Skipper/ HEXAGON/Liberty/NRG/B125/X8 /X9/ET2/ET4/LX/LX2/LX4/LXV/S /GT/GTS/GTV" service & repairs, German, 434 p., 1356 illustrations, 30 circuit diagrams, 2nd edition	29,90 EUR

97		99460000	Hand Book "Vespa GT, GTS, GTV - Automatic Scooters" technical data, service & repairs, all 4-stroke 125cc -300cc from 2003, German, 152 p., l=210mm, w=150mm, h 10,0mm, 329 photos, 100 colored, 53 paintings	16,90 EUR
97		98962000	Repair Manual "Vespa GTS- and GTV models 125, 250, 300 i.e." since 2005 with watercooled 4 -stroke injection engine, German, 176 p., w=200mm, h 280,0mm	34,90 EUR
98		14235000	Brake Cleaner SIP 500ml, spray	3,90 EUR
98		30021000	Brake Fluid DOT 5.1, synthetic, 250ml	6,90 EUR
98		14131000	Skin Cleaner "Fast Orange", 440ml	7,90 EUR
98		14130000	Skin Cleaner LOCTITE SF 7850, 400ml	12,20 EUR
98		14110000	Hand Cleaner (paste) TEROSON /HENKEL 300g	6,30 EUR
98		14230000	Brake Cleaner MASTERCARE /REPSTAR 500ml, spray	3,50 EUR
98		14082100	Tyre Fitting Paste allround mounting paste, 1000g	14,90 EUR
98		30100000	Copper Paste LIQUI MOLY 100g	9,40 EUR
99A		20842000	Chuck SIP lower bearing shell upper steering column removal, for Vespa all models also for GILERA/PIAGGIO alle Modelle	22,00 EUR
99A		15211100	Rim Protectors for Tyre Fitting 2 pcs	8,90 EUR
99A		BU5420	Steering Head Bearing Nut SIP universal, for GILERA/PIAGGIO/Vespa all models Grade A - perfect repair	32,00 EUR
99A		15213000	Tyre Fitting Tool BUZZETTI L=380 mm, with plastic cover	16,50 EUR
99A		20837527	Tool valve insert De-/mounting 125 mm	3,00 EUR
99B		14528500	Bracket emission sticker, for french Crit'air vignette, black, plastic, Ø 70 mm, strap=320x15mm	19,90 EUR

99B		MXMG05L	Gloves Mechanix The Original, black, unisex, size L, 60% nylon, 35% polyurethan, 5% elastane	29,90 EUR
99B		14528200	Bracket road tax disc, for Austrian annual vignette, black, plastic, strap=320x15mm	12,90 EUR
99B		14528400	Bracket insurance vignette, for french assurance vignette, Certificat d'assurance, black, plastic, l 70 mm, w 50 mm, strap=320x15mm	19,90 EUR
99B		12194000	Knee Pad SIP 435x195x30 mm, foam EVA, black /red	10,20 EUR
99B		14528300	Bracket Pickerl, for Austrian inspection badge, black, plastic, strap=320x15mm	13,90 EUR
99B		12194100	Floor Mat SIP 3 in 1 1210x420x30 mm, foam EVA, black/red, knee pad, cushion and floor mat all in one	24,90 EUR