

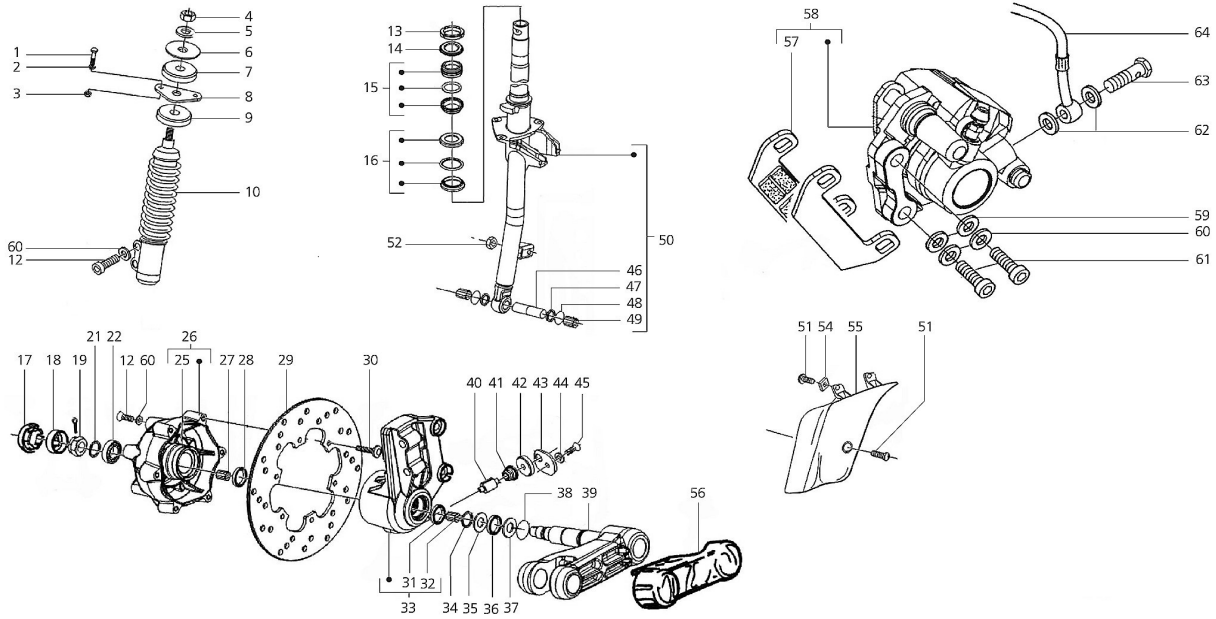









EX40 Chassis ET2/ET4 - Fork/Steering Column









		Prod.no.	Product name	Gross Price
1		30078000	Screw M8x25 mm, hexagonal, AF 13mm, steel, zinc plated, 8.8	0,60 EUR
2		80005000	Spring Washer M8 mm, Ø 8,1x1.. ..4,8 mm, (th) 2mm, spring steel, zinc coated	0,20 EUR
3		20008000	Nut M8x8 mm, shock absorber rear, top, for Vespa V50/PV/ET3/PK/PX /Lusso/VNA-T4/GS160/SS180, mounting single saddle holding for Vespa V50/PV/ET3, engine stud PIAGGIO/GILERA Maxi, engine casing ET4 old engine	0,90 EUR
4		21210000	Nut M10x1,25 mm, 04, steel, zinc plated, AF 17mm, h 6,0mm, shock absorber, front, top, for Vespa PK/S/XL/XL2 Automatica/PX/T5/ET2/ET4/LX /LXV/S/GT/GTL/GTV/GTS, (1), oil tank outlet for Vespa PX/T5, (1)	1,40 EUR
5		12535000	Lock Washer shock absorber, front, top, Ø i 10,5mm, Ø a 18 mm, for Vespa PK/S/XL/XL2/ Automatica/PX/T5/Cosa/SKR flywheel for Vespa 50 R-S -Special V5B3-90-100/125 PV 2°/ET3/PK50-125 S-PK125 2° /PK50 SS, spring steel, zinc coated	0,70 EUR
6		17408800	Washer shock absorber, front, top, Ø 35x10,5x2 mm, for Vespa PK/S/XL/XL2/ Automatica/PX/T5/Cosa	1,40 EUR

7		30568000	Rubber Engine Mounting Bush Kit shock absorber, CLAUSS STUDIOS front, top, 17x38x9 mm, for Vespa PX80-200/PE/Lusso / 98/ MY/T5/Cosa 125-150 Elestart/LML Star 125-200 2T /4T/Deluxe 2T/4S/Speedy /Stella also for Vespa LX/LXV/S /Primavera/Sprint/GTS/GTS Super/GTV/GT 60/GT/GT L/946 50-300ccm, polyurethane, incl. nut/washer for a first-class repair - grade AA for tuned engines	13,90 EUR
7		21620900	Rubber Engine Mounting Bush shock absorber, front, top, 10 mm, Ø (inner) 14mm, (outer) 30 mm, for Vespa V50/PV/ ET3/PK/S/XL /XL2/Automatica/SKR	3,30 EUR
8		22574800	Shock Absorber Base Plate front, for Vespa PK/S/XL/ XL2 /Automatica/ET2/ET4 also for PIAGGIO ZIP	11,20 EUR
10		25441007	Shock Absorber PINASCO front for Vespa ET2/ET4/LX/LXV/S 50 -150ccm, for Vespa PK 50-125 S /SS/XL/N/ETS body: black /silver, spring: yellow, spring pre-load: continuously adjustable, SPORT chassis - comfortable	177,00 EUR
10		R204584211	Shock Absorber RMS front for Vespa LX/LXV 50-150ccm, body: silver, spring: black, l 247 mm, STANDARD chassis - like original	49,00 EUR
10		CARB0010	Shock Absorber CARBONE HiTech front for Vespa ET2/ET4/LX/LXV /S 50-150ccm, also for PIAGGIO Quartz/SKR body: black, spring: black, l 208 mm, stiffness: reinforced, spring pre-load: continuously adjustable, SPORT chassis - comfortable	158,00 EUR
10		ZELSLF01	Shock Absorber ZELIONI front for Vespa ET2/ET4/LX/LXV/S 50 -150ccm, body: silver/orange, spring: black, seating: fork, compression stroke: 9-times, spring pre-load: continuously adjustable, rebound adjustment: 20 settings, aluminium CNC, SPORT chassis - comfortable	329,00 EUR

10		YSS9042101	Shock Absorber YSS Mono X-Pro Series front for Vespa ET2/ET4 /LX/LXV/S 50-150ccm, for Vespa PK 50-125 S/SS/XL/N/ETS body: black, spring: black, l 210 mm, with ABE, spring pre-load: adjustable, SPORT chassis - comfortable	75,00 EUR
10		PV039GEV01	Shock Absorber BITUBO GAV front for Vespa ET2/ET4 50 -150ccm, body: black, spring: red, l 235 mm, SPORT chassis - comfortable	219,00 EUR
10		PI598922	Shock Absorber PIAGGIO front for Vespa ET2/ET4 50-150ccm, body: silver, spring: black, STANDARD chassis - like original	89,00 EUR
10		C6308BB	Shock Absorber CIF Sport front for PIAGGIO Quartz/SKR/ET2/ET4, also for Vespa PK50-125/S/XL /XL2/ETS body: black, spring: chrome, l 210 mm, stiffness: reinforced, STANDARD chassis - like original	69,00 EUR
10		222164A0	Shock Absorber CARBONE Sport front for Vespa ET2/ET4 50 -150ccm, body: black, spring: red, seating: thread/fork, SPORT chassis - comfortable	68,00 EUR
12		14910400	Screw M8x40 mm, inner hexagonal, mirror, for Vespa Cosa FL, shock absorber front, lower (2) for Vespa PX`98/MY/ET2/ET4 /LX/LXV/S/GTS/GTS Super/GTV /GT 60/GT/GT L/946 50-300ccm, wheel stud for Vespa GTS/GTS Super/GTV/GT 60/GT/GT L/946 125-300ccm	1,50 EUR
12		TI840BK	Screw M8x40 mm, inner hexagonal, titanium, black, rim, for Vespa GTS/GTS Super/GTV/GT 60/GT/GT L/946 125-300ccm, shock absorber front, lower for Vespa PX`98/MY/ET2/ET4/LX /LXV/S/GTS/GTS Super/GTV/GT 60/GT/GT L/946 50-300ccm	10,50 EUR
12		TI840GO	Screw M8x40 mm, inner hexagonal, titanium, gold -coloured, rim, for Vespa GTS/GTS Super/GTV/GT 60/GT/GT L/946 125-300ccm, shock absorber front, lower for Vespa PX`98/MY/ET2/ET4/LX /LXV/S/GTS/GTS Super/GTV/GT 60/GT/GT L/946 50-300ccm	7,90 EUR

12		TI840SL	Screw M8x40 mm, inner hexagonal, titanium, silver, rim, for Vespa GTS/GTS Super/GTV/GT 60/GT/GT L/946 125-300ccm, shock absorber front, lower for Vespa PX`98/MY/ET2/ET4/LX /LXV/S/GTS/GTS Super/GTV/GT 60/GT/GT L/946 50-300ccm	10,50 EUR
12		TI840BL	Screw M8x40 mm, inner hexagonal, titanium, blue, rim, for Vespa GTS/GTS Super/GTV/GT 60/GT/GT L/946 125-300ccm, shock absorber front, lower for Vespa PX`98/MY/ET2/ET4/LX /LXV/S/GTS/GTS Super/GTV/GT 60/GT/GT L/946 50-300ccm	7,90 EUR
13		11109000	Nut h 5,2mm, steering head bearing/column, top, for Vespa 50-125/PV/ET3/PK50 -125/S/SS/XL/125 VM/VN/VNA -TS/150 VL/VB/GS/VBA-T4 /160 GS/180 SS/Rally/PX80-200/PE /Lusso/'98/MY/'11, (0), also for LML Star 125-200 2T /4T/ Star 125/II/Lite 4T Automatica/CVT, (0) Grade A - perfect repair	4,90 EUR
14		PI582787	Locking Washer steering head bearing, PIAGGIO top, Ø 30/40 mm, (th) 2,5mm, for Vespa ET2/ET4/GTS/GTS Super/GTV/GT 60/GT/GT L 50 -300ccm also for APRILIA/GILERA /PIAGGIO	1,30 EUR
14		37510000	Locking Washer steering head bearing, top, Ø 40x30x2,6 mm, for Vespa 50-125/PV/ET3/PK50 -125/S/SS/XL/125 VM/VN/VNA -TS/150 VL/VB/GS/VBA-T4 /160 GS/180 SS/Rally/PX80-200/PE /Lusso/'98/MY/'11 also for LML Star 125-200 2T /4T/ Star 125/II/Lite 4T Automatica/CVT, Grade A - perfect repair	2,90 EUR
15		90102000	Steering Head Bearing Set top for Vespa 50-125/PV/ET3/PK50 -125/S/SS/XL/125 GT-TS/ 150 Sprint/V/Super/160 GS/180 SS /Rally/PX80-200/PE/Lusso/'98 /MY/'11/T5/Cosa, also for GILERA/PIAGGIO 50 -300ccm Automatik PIAGGIO, Ø bearing shell frame top 31x36,55-42,90mm/ Ø ball 4,0 mm, w/o nut steering head/circlip, Grade A - perfect repair	16,50 EUR









15		90100000	Steering Head Bearing Set top for Vespa 50-125/PV/ET3/PK50 -125/S/SS/XL/125 GT-TS/ 150 Sprint/V/Super/160 GS/180 SS /Rally/PX80-200/PE/Lusso/'98 /MY/'11/T5/Cosa, also for GILERA/PIAGGIO 50 -300ccm Automatik Ø bearing shell frame top 31x36,55-42,90mm/ Ø ball 3,2 mm, incl. nut steering head /circlip	16,90 EUR
16		90115000	Steering Head Bearing Set lower for Vespa 50-125/PV/ET3/PK50 -125/S/SS/XL/125 GT-TS/ 150 Sprint/V/Super/160 GS/180 SS /Rally/PX80-200/PE/Lusso/'98 /MY/'11/T5/Cosa, also for GILERA/PIAGGIO 50 -300ccm Automatik PIAGGIO, Ø bearing shell frame top 31x36,55-42,90mm/ Ø ball 6,35 mm, incl. dust cover, Grade A - perfect repair	17,90 EUR
16		90110000	Steering Head Bearing Set lower for Vespa 50-125/PV/ET3/PK50 -125/S/SS/XL/125 GT-TS/ 150 Sprint/V/Super/160 GS/180 SS /Rally/PX80-200/PE/Lusso/'98 /MY/'11/T5/Cosa, also for GILERA/PIAGGIO 50 -300ccm Automatik Ø bearing shell frame lower 36,7x64/ bearing shell steering column 35x46,8/ dust cover steering column 35x63 mm, incl. dust cover, Grade B - decent repair	15,50 EUR
17		87220000	Hub Nut Cover brake drum, front & rear, for Vespa 50 Special V5B1-4T/SS/90 R/SS /100 2°/125/PV/ET3/125 GT /GTR/TS/150 GL/GS VS5T /Sprint/V/160 GS/180 SS /Rally/P200E 2°/PX80-150 E 2°/Lusso/'98/MY/'11/T5 rear for Vespa 125 VGLA/B/P80 -150X/P200E 1°/PX80-150 E 1° Ø 36 mm, metal, chrome	3,90 EUR
17		87227000	Hub Nut Cover brake drum, front & rear, for Vespa 50 Special V5B1-4T/SS/90 R/SS /100 2°/125/PV/ET3/125 GT /GTR/TS/150 GL/GS VS5T /Sprint/V/160 GS/180 SS /Rally/P200E 2°/PX80-150 E 2°/Lusso/'98/MY/'11/T5 rear for Vespa 125 VGLA/B/P80 -150X/P200E 1°/PX80-150 E 1° Ø 35 mm, plastic, black	4,90 EUR

18		17760900	Locking Washer brake drum, front, for Vespa PK50-125/S/SS /XL/XL2/Automatica/PX80-200E 2°/Lusso/ 98/MY/ 11/T5/Cosa /LML Star 125-200 2T/4T/ Star 125/II/Lite 4T Automatica/CVT brake drum front for Vespa ET2/ET4/LX/LXV/S/Primavera/GTS /GTS Super/GTV/GT 60/GT/GT L /946 50-300ccm Grade A - perfect repair	2,30 EUR
18		53419230	Locking Washer LML brake drum, front, for Vespa PK50-125/S/SS /XL/XL2/Automatica/PX80-200E 2°/Lusso/ 98/MY/ 11/T5/Cosa /LML Star 125-200 2T/4T/ Star 125/II/Lite 4T Automatica/CVT also for Vespa ET2/ET4/LX/LXV /S/Primavera/GTS/GTS Super /GTV/GT 60/GT/GT L/946 50 -300ccm Grade C - low-priced repairs	2,00 EUR
19		12640900	Nut M14x1,5 mm, steel, zinc plated, AF 22mm, h 10,5mm, brake drum, front, for Vespa PK50-125/S/SS/XL/XL2 /Automatica/PX80-200E 2° /Lusso/ 98/MY/ 11/T5/Cosa /LML Star 125-200 2T/4T/ Star 125/II/Lite 4T Automatica/CVT, engine stud for Vespa PX/T5	2,00 EUR
21		66350000	Cluster Circlip P/A front brake drum bearing, for Vespa PK/S/XL/XL2/ PX Lusso/ 98/ T5 /Cosa bearing drive shaft Variator cover for PIAGGIO Leader /Quasar 125-300ccm 4T AC/LC Ø 20 mm	1,30 EUR
22		17761000	Bearing brake drum 20mm for Vespa PK/S/XL/XL2/PX Lusso / 98/T5/Cosa, drive shaft Variator cover for PIAGGIO Leader/Quasar 125-300ccm 4T AC/LC brake drum for LML Star 125 -200 2T/4T/Deluxe 2T/4S /Speedy/Stella SKF, capsuled, 15x35x11 mm, fits also for rear wheel axle HONDA	12,50 EUR
25		PI267818	Gear Ring PIAGGIO speedometer drive, for Vespa ET2/ET4/LX/LXV/S/GTS /GTS Super/GT/GT L 50-300ccm also for GILERA/PIAGGIO Fuoco /Hexagon/MP3/Quartz/Sfera RST/SKR/ZIP II/SP, 15 teeth	22,70 EUR

26		MV669149S	Wheel Hub G-PRO front, for Vespa Primavera/Sprint 125 -150ccm ABS also for PIAGGIO /Vespa ET2/ET4/LX/LXV/S /Hexagon/Sfera RST/ZIP II/SP 50-150ccm, aluminium CNC, silver anodised, incl. bearing	169,00 EUR
26		MV669149B	Wheel Hub G-PRO front, for Vespa Primavera/Sprint 125 -150ccm ABS also for PIAGGIO /Vespa ET2/ET4/LX/LXV/S /Hexagon/Sfera RST/ZIP II/SP 50-150ccm, aluminium CNC, black anodised, incl. bearing	169,00 EUR
26		WHL001BK	Wheel Hub OTTOPUNTO front, for Vespa ET2/ET4/LX/LXV/S 50 -150ccm also for PIAGGIO Hex.. ..agon/Sfera RST/ZIP II/SP, aluminium CNC, black anodised	159,00 EUR
26		P0502127	Wheel Hub POLINI front, for Vespa ET2/ET4/LX/LXV/S 50 -150ccm also for PIAGGIO Hex.. ..agon/Sfera RST/ZIP II/SP, aluminium CNC, black, RACE chassis - first-class	159,00 EUR
26		PI560284	Wheel Hub PIAGGIO front, for Vespa ET2/ET4/LX/LXV/S 50 -150ccm also for PIAGGIO Hex.. ..agon/Sfera RST/ZIP II/SP	139,00 EUR
27		17019000	Bearing brake drum inside for Vespa PK/S/XL/XL2/ PX80 -200E/Lusso/ 98/MY/T5/Cosa, also for LML Star 125-200 2T /4T/Deluxe 2T/4S/Speedy /Stella 20x26x16 mm, HK2016	9,30 EUR
28		17744300	Oil Seal brake drum inside for Vespa PK/S/XL/ XL2/PX80 -200E/Lusso/ 98/MY/T5/ Cosa, also for LML Star 125-200 2T /4T/Deluxe 2T/4S/Speedy /Stella 20x26x4 mm, Grade A - perfect repair	4,60 EUR
29		17620600	Brake Disc GRIMECA Standard, for Vespa PX 125-200 E `98/MY / 11/ET2/ET4/LX/LXV/S /Primavera/Sprint 50-150ccm /LML Star 125-200 2T/4T, also for GRIMECA Classic NT /PX`98/LML Ø 200/97/4 mm, 5-hole, Grade A - perfect repair	55,00 EUR
29		56324600	Brake Disc PIAGGIO Standard, for Vespa PX 125-200 E `98/MY / 11/ET2/ET4/LX/LXV/S /Primavera/Sprint 50-150ccm /LML Star 125-200 2T/4T, also for GRIMECA Classic NT /PX`98/LML Ø 200/97/4 mm, 5-hole, Grade B - decent repair	39,00 EUR















29		GF650RW	Brake Disc GALFER Wave Extreme, front, for Vespa PX 125-200 E `98/MY/` 11/ET2/ET4/LX/LXV/S /Primavera/Sprint 50-150ccm /LML Star 125-200 2T/4T, also for GRIMECA Classic NT /PX`98/LML Ø 200/97/4 mm, 5-hole, extreme	159,00 EUR
29		M629078	Brake Disc MALOSSI MHR front, for Vespa PX 125-200 E `98/MY /` 11/ET2/ET4/LX/LXV/S /Primavera/Sprint 50-150ccm /LML Star 125-200 2T/4T, also for GRIMECA Classic NT /PX`98/LML 200/97/4,0 mm 5-hole	95,00 EUR
29		56324700	Brake Disc CRIMAZ front, for Vespa PX 125-200 E `98/MY/` 11 /ET2/ET4/LX/LXV/S/Primavera /Sprint 50-150ccm/LML Star 125-200 2T/4T, also for GRIMECA Classic NT /PX`98/LML 200/97/3,5 mm 5-hole	124,00 EUR
29		R22516016	Brake Disc RMS Standard, for Vespa PX 125-200 E `98/MY/` 11 /ET2/ET4/LX/LXV/S/Primavera /Sprint 50-150ccm/LML Star 125-200 2T/4T, also for GRIMECA Classic NT /PX`98/LML Ø 200/97/4 mm, 5-hole	47,00 EUR
29		P1750006	Brake Disc POLINI ROAD, front, for Vespa PX 125-200 E `98/MY /` 11/ET2/ET4/LX/LXV/S /Primavera/Sprint 50-150ccm /LML Star 125-200 2T/4T, also for GRIMECA Classic NT /PX`98/LML Ø 200/97/4 mm, 5-hole, floating	87,00 EUR
29		P1750044	Brake Disc POLINI for Vespa PX 125-200 E `98/MY/` 11/ET2 /ET4/LX/LXV/S/Primavera /Sprint 50-150ccm/LML Star 125-200 2T/4T, Ø 200x96,2x4 mm, M6 mm 5-hole	55,00 EUR
29		P1750010	Brake Disc POLINI RACE, front, for Vespa PX 125-200 E `98/MY /` 11/ET2/ET4/LX/LXV/S /Primavera/Sprint 50-150ccm, also for GRIMECA Classic NT /PX`98/LML Ø 200/96,5/4 mm, 5-hole, floating, w/o sound absorbing springs	99,00 EUR











29		GF650W	Brake Disc GALFER WAVE, front, for Vespa PX 125-200 E `98/MY / `11/ET2/ET4/LX/LXV/S /Primavera/Sprint 50-150ccm /LML Star 125-200 2T/4T, also for GRIMECA Classic NT /PX`98/LML Ø 200/98/4 mm, with KBA, 5-hole	45,00 EUR
29		37214150	Brake Disc LML Standard, for Vespa PX 125-200 E `98/MY/ `11 /ET2/ET4/LX/LXV/S/Primavera /Sprint 50-150ccm/LML Star 125-200 2T/4T, also for GRIMECA Classic NT /PX`98/LML Ø 200/97/3,5 mm, 5-hole, Grade C - low-priced repairs	45,00 EUR
30		47216200	Screw M6x20 mm, inner hexagonal, round head, LML for Vespa PX`98/MY, for Vespa ET2/ET4/LX/LXV/S/GTS /GTS Super/GTS Super Sport /GTV/GT 60/GT/GT L, 50 -300ccm, for LML Star 125-200 2T/4T /Deluxe 2T/4S/Speedy/Stella Grade C - low-priced repairs	0,70 EUR
30		TI620GO	Screw M6x20 mm, inner hexagonal, round head, titan.. ..ium, gold-coloured, brake disc, for Vespa PX`98/MY, for Vespa ET2/ET4/LX/LXV/S/GTS /GTS Super/GTS Super Sport /GTV/GT 60/GT/GT L, 50 -300ccm	5,50 EUR
30		TI620BK	Screw M6x20 mm, inner hexagonal, round head, titan.. ..ium, black, brake disc, for Vespa PX`98/MY, for Vespa ET2/ET4/LX/LXV/S/GTS /GTS Super/GTS Super Sport /GTV/GT 60/GT/GT L, 50 -300ccm	5,20 EUR
30		27114700	Screw M6x20 mm, inner hexagonal, round head, brake disc, for Vespa PX`98/MY, for Vespa ET2/ET4/LX/LXV/S/GTS /GTS Super/GTS Super Sport /GTV/GT 60/GT/GT L, 50 -300ccm, also for LML Star 125-200 2T /4T/Deluxe 2T/4S/Speedy /Stella with screw locking, for a first-class repair - grade AA	0,90 EUR











30		TI620BL	Screw M6x20 mm, inner hexagonal, round head, titanium, blue, brake disc, for Vespa PX 98/MY, for Vespa ET2/ET4/LX/LXV/S/GTS/GTS Super/GTS Super Sport/GTV/GT 60/GT/GT L, 50-300ccm	4,90 EUR
31		50411020	Oil Seal brake base plate 20mm front for Vespa PK/S/XL/XL2/PX/Lusso/'98, for LML Star 125-200 2T/4T/Deluxe 2T/4S/Speedy/Stella LML, 46x56x4 mm, metal Grade C - low-priced repairs	4,50 EUR
31		17749400	Oil Seal brake base plate 20mm front for Vespa PK/S/XL/XL2/PX/Lusso/'98, for LML Star 125-200 2T/4T/Deluxe 2T/4S/Speedy/Stella 46x56x4 mm, Grade A - perfect repair	5,30 EUR
32		17744200	Bearing brake base plate 20mm front for Vespa PK/S/XL/XL2/PX80-200E/Lusso/'98/MY/T5/Cosa, RMS, 22x28x12 mm	7,10 EUR
33		P0502252	Axle Seating POLINI brake calliper/shock absorber front, for Vespa ET2/ET4/LX/LXV/S 50-150ccm also for PIAGGIO Sfera RST/ZIP II/ZIP SP 50-125ccm blue, for a better drivability	119,00 EUR
33		BRK038BK	Axle Seating OTTOPUNTOUNO for radial brake calliper, front, for Vespa ET2/ET4/LX/LXV/S/Primavera/Sprint/PIAGGIO ZIP II/FR/SP 50-150ccm fits also in connection with conversion steering column SIP PIAGGIO ZIP SP aluminium CNC, black anodised, incl. bearing	159,00 EUR
33		PI560286	Axle Seating PIAGGIO brake calliper/shock absorber front, for Vespa ET2/ET4/LX/LXV/S 50-150ccm also for PIAGGIO Sfera RST/ZIP II/ZIP SP 50-125ccm	105,00 EUR
34		50411240	Cluster Circlip LML brake base plate, for Vespa PK/S/XL/XL2/PX80-200E/Lusso/'98/MY/T5/Cosa for LML Star 125-200 2T/4T/Deluxe 2T/4S/Speedy/Stella Ø 20 mm, Grade C - low-priced repairs	1,10 EUR

34		64220000	Cluster Circlip brake base plate, inner, for Vespa PK/S /XL/XL2/PX80-200E/Lusso/ 98 /MY/T5/Cosa for LML Star 125-200 2T/4T /Deluxe 2T/4S/Speedy/Stella Ø 20 mm, for a first-class repair - grade AA	1,80 EUR
35		17741400	Spacer brake base plate 20mm, front, for Vespa PK/S/XL/XL2/PX80 -200E/Lusso/ 98/MY/T5 for LML Star 125-200 2T/4T /Deluxe 2T/4S/Speedy/Stella, for a first-class repair - grade AA	1,50 EUR
36		17752100	Sealing Ring axle seating 20mm for Vespa PK/S/XL/XL2/PX Lusso /T5/Cosa for LML Star 125-200 2T/4T /Deluxe 2T/4S/Speedy/Stella 21-27-4 V-lip Grade A - perfect repair	1,50 EUR
36		50411030	Sealing Ring axle seating 20mm front for Vespa PK/S/XL/XL2/PX Lusso /T5/Cosa, for LML Star 125-200 2T/4T /Deluxe 2T/4S/Speedy/Stella LML, 21-28-4 V-lip, Grade C - low -priced repairs	1,00 EUR
37		17744500	Spacer axle seating, front, Ø 36,5x22 mm, for Vespa PK/S/ XL/XL2/PX80 -200E/Lusso/ 98/MY/T5 also for LML Star 125-200 2T /4T/Deluxe 2T/4S/Speedy /Stella, Grade A - perfect repair	1,80 EUR
38		17740800	O-Ring axle seating, PIAGGIO front, Ø 38 mm, (th) 1,7mm, for Vespa PK/S/XL/XL2/PX Lusso /T5/Cosa also for LML Star 125-200 2T /4T/ Star 125/II/Lite 4T Automatica/CVT, Grade A - perfect repair	1,40 EUR
39		PI648397	Swing Arm PIAGGIO front, for Vespa ET2/ET4/LX/LXV/S/946 /GTS/GTS Super/GTV/GT 60/GT /GT L 50-300ccm 2T/4T for PIAGGIO Hexagon/MP3 Yourban /Sfera RST/ZIP	52,00 EUR
40		PI267819	Speedometer Drive Gear for PIAGGIO/Vespa Hexagon/Quartz /Sfera RST/SKR/ZIP II/SP/ET2 /ET4/LX/LXV/S/GTS/GTS Super /GT/GT L 50-300ccm 12 teeth	4,90 EUR
41		56405300	Gear Guide speedometer drive gear, for Vespa PX `98/MY also for Vespa ET2/ET4/LX/LXV /S/GTS/GTS Super/GTV/GT 60 /GT/GT L, 50-300ccm	4,00 EUR

42		PI266841	Rubber passage speedometer drive, for PIAGGIO/Vespa Hexagon /Quartz/Sfera RST/SKR/ZIP II /SP/ET2/ET4/LX/LXV/S/GTS/GTS Super/GTV/GT 60/GT/GT L 50 -300ccm	1,40 EUR
43		PI269118	Washer mounting speedometer cable, for PIAGGIO/Vespa Hexagon /Quartz/Sfera RST/SKR/ZIP II /SP/ET2/ET4/LX/LXV/S/GTS/GTS Super/GTV/GT 60/GT/GT L 50 -300ccm	1,60 EUR
45		21056000	Screw M5x12 mm, hexagonal, AF 8mm, steel, zinc plated, 8.8, mounting speedometer cable, for Vespa V50/PV/ET3/PK/PX/T5 /Cosa, (1), base plate cable lever for Vespa 50/N/L/R/S/SR/90/R/125 /PV/GT/GTR/Super/150 GL /Sprint/Veloce/ Super/180 Rally/SS/200 Rally, rear light for Vespa PK50/S(I)	0,90 EUR
46		17745100	Bearing Set Suspension Arm for Vespa PK50-125/S/SS/XL/XL2 /P150X 346431->/PX125 1116-> /P200E 112625->/PX100/PX80 -200E Lusso/'98/MY/'11/T5 /Cosa, for LML Star 125-200 2T/4T/ Star 125/II/Lite 4T Automatica/CVT P/A, for 20mm axle, bolt: 16x56mm, Ø bearing outside: 22 mm, incl. O-rings, locking plates, Grade A - perfect repair	16,20 EUR
47		11921900	Sealing Ring suspension bolt 20mm (outside) for Vespa PK/S /XL/ XL2/PX80-200E/Lusso/'98 /MY/T5	1,60 EUR
48		67310000	Sealing Ring suspension bolt 20mm (inside) for Vespa PK/S /XL/ XL2/PX80-200E/Lusso/'98 /MY/T5 31x25x4mm	1,90 EUR
49		19851300	Bearing suspension arm for Vespa PK/S/XL/XL2/ PX80 -200E/Lusso/'98/MY/T5/ Cosa	7,90 EUR
50		PI600959	Steering Column PIAGGIO for Vespa ET2/ET4 50-150cc, incl. suspension arm	215,00 EUR
51		PI575249	Screw M6x16 mm, cover, with collar, black	1,00 EUR
52		17827000	Nut M6 mm, 10, steel, zinc plated, AF 10mm, h 5,0mm	0,20 EUR
54		PI254485	Clip cover automatic scooter, speed nut M6	0,80 EUR



55		PI821705A7	Fork Cover PIAGGIO for Vespa ET2/ET4 50-150ccm silver, Platino 686	49,00 EUR
55		PI821705C1	Fork Cover PIAGGIO for Vespa ET2/ET4 50ccm blue, Cielo 270	49,00 EUR
55		PI821700AA	Fork Cover PIAGGIO for Vespa ET2/ET4 50-150ccm blue, Aurora 422	49,00 EUR
55		PI82170536	Fork Cover PIAGGIO for Vespa ET2 50ccm red, Firenze 845	49,00 EUR
55		PI82170587	Fork Cover PIAGGIO for Vespa ET4 50-150ccm white, Ottico 724	49,00 EUR
55		PI821705R7	Fork Cover PIAGGIO for Vespa ET2/ET4 50-150ccm red, Dragon 894	49,00 EUR
55		PI821705V3	Fork Cover PIAGGIO for Vespa ET2/ET4 50ccm green, Jade 386	49,00 EUR
55		PI82170559	Fork Cover PIAGGIO for Vespa ET4 125ccm brown, Tabacco 131	26,00 EUR
55		PI82170595	Fork Cover PIAGGIO for Vespa ET2/ET4 50-150ccm silver, Moonlight 729	49,00 EUR
55		PI821705D1	Fork Cover PIAGGIO for Vespa ET2/ET4 50-150ccm blue, Cobalt 251	49,00 EUR
55		PI821705F1	Fork Cover PIAGGIO for Vespa ET2/ET4 50-150ccm purple, Lavenda 523	49,00 EUR
55		PI821700F2	Fork Cover PIAGGIO for Vespa ET2/ET4 50-150ccm silver, Excalibur 738/A	59,00 EUR
56		5614330C	Suspension Arm Cover SLUK for Vespa ET2/ET4/LX/LXV/S/GTS /GTS Super/GTV/GT 60/GT/GT L 50-300 (03-13/17-) plastic, carbon-look, also for Vespa Primavera /Sprint 50-150ccm (17-), adhesive coating	35,00 EUR
56		MV561433B	Suspension Arm Cover SIP for Vespa ET2/ET4/LX/LXV/S/GTS/GTS Super/GTV/GT 60/GT/GT L 50 -300 (03-13/17-) plastic, black shiny, also for Vespa Primavera /Sprint (17-)	14,90 EUR
56		56143300	Suspension Arm Cover SLUK for Vespa ET2/ET4/LX/LXV/S/GTS /GTS Super/GTV/GT 60/GT/GT L 50-300 (03-13/17-) plastic, black, also for Vespa Primavera /Sprint 50-150ccm (17-), adhesive coating	29,00 EUR

56		PI650264	Suspension Arm Cover PIAGGIO for Vespa ET2/ET4/LX/LXV/S/GTS /GTS Super/GTV/GT 60/GT/GT L 50-300 (03-13/17-) plastic, silver matt, also for Vespa Primavera /Sprint (17-), with "Vespa" badge	23,90 EUR
56		65026100	Cooling Hood disc brake, CRI.. ..MAZ for Vespa ET2/ET4/LX/LXV/S/GTS /GTS Super/GTV/GT 60/GT/GT L 50-300ccm also for PIAGGIO ZIP/SFERA/SKR, plastic, primed, incl. cooling for disc brake	40,00 EUR
56		MV400033	Suspension Arm Cover SIP for Vespa ET2/ET4/LX/LXV/S/GTS/GTS Super/GTV/GT 60/GT/GT L 50-300 (03-13/17-) plastic, chrome, also for Vespa Primavera /Sprint (17-), "Old Style"	19,00 EUR
56		MV561433MB	Suspension Arm Cover SIP for Vespa ET2/ET4/LX/LXV/S/GTS/GTS Super/GTV/GT 60/GT/GT L 50-300 (03-13/17-) plastic, matt black, also for Vespa Primavera /Sprint (17-)	14,90 EUR
56		PI561433	Suspension Arm Cover PIAGGIO for Vespa ET2/ET4/LX/LXV/S/GTS /GTS Super/GTV/GT 60/GT/GT L 50-300 (03-13/17-) plastic, chrome, also for Vespa Primavera /Sprint (17-)	11,90 EUR
56		PI561433B	Suspension Arm Cover PIAGGIO for Vespa ET2/ET4/LX/LXV/S/GTS /GTS Super/GTV/GT 60/GT/GT L 50-300 (03-13/17-) plastic, black, also for Vespa Primavera /Sprint (17-)	29,90 EUR
57		P1742014	Brake Pads POLINI Sintered, S14, 48,8x35,5x7,0 mm with e-pass	20,90 EUR
57		PI647157	Brake Pads PIAGGIO S14, for HENG TONG brake calliper, front left/right, for GILERA /PIAGGIO FUOCO 500ccm/MP3 125-500ccm, 49x35x7,0 mm	16,90 EUR
57		MCB695	Brake Pads LUCAS S14, 48,8x35,3x6,9 mm with e-pass	14,50 EUR
57		M6215006	Brake Pads MALOSSSI MHR Synt, S14, 48,8x35,3x6,9 mm with e-pass, e24 mark	14,90 EUR
57		P1740014	Brake Pads POLINI Original, S14, 48,8x35,5x7,0 mm with e-pass	9,90 EUR

57		M6215049	Brake Pads MALOSSI Sport, S14, 48,8x35,3x6,9 mm with e-pass, e24 mark	8,50 EUR
57		M6215074	Brake Pads MALOSSI MHR, S14, 48,8x35,3x6,9 mm with e-pass	8,90 EUR
57		GF1454	Brake Pads GALFER SPORT S14, 49x35x7,0 mm with e-pass	13,50 EUR
57		R22510030	Brake Pads RMS S14, 49x35x7,0 mm with e-pass	10,90 EUR
58		MV564230	Brake Calliper SIP front, for Vespa LX/LXV/S/ 50-150/125 Primavera 3V (Vietnam Modell), black, Ø 31,5 mm, with e-pass, KBA 61372	105,00 EUR
58		MV564260	Brake Calliper SIP front, for Vespa LX/LXV/S/ 50-150/125 Primavera 3V (Vietnam Modell), gold, Ø 31,5 mm, with e-pass, KBA 61372	109,00 EUR
58		MV564240	Brake Calliper SIP front, for Vespa LX/LXV/S/ 50-150/125 Primavera 3V (Vietnam Modell), red, Ø 31,5 mm, with e-pass, KBA 61372	105,00 EUR
58		P0502238	Brake Calliper POLINI front, for Vespa ET2/ET4/LX/LXV/S 50-150ccm also for PIAGGIO Liberty/ZIP II/ZIP SP 50-150ccm, Ø 32 mm, aluminium CNC, 2 pistons	249,00 EUR
58		GR362410	Brake Calliper PIAGGIO front, HENG TONG for Vespa ET2/ET4/LX/LXV/S 50-150/PIAGGIO Liberty/ZIP II /FR/SP 50-200ccm fits also in connection with conversion steering column SIP PIAGGIO ZIP SP for Vespa 50-125/PV/ET3 /PK50-125/S/SS/XL/Automatica /125 VNA-TS/150 VBA-Super /Rally, Ø 30 mm, black anodised	77,00 EUR
58		MV564210	Brake Calliper SIP front, for Vespa LX/LXV/S/ 50-150/125 Primavera 3V (Vietnam Modell), silver, Ø 31,5 mm, with e-pass, KBA 61372	109,00 EUR
58		MV564250	Brake Calliper SIP front, for Vespa LX/LXV/S/ 50-150/125 Primavera 3V (Vietnam Modell), titanium, Ø 31,5 mm, with e-pass, KBA 61372	109,00 EUR

59		56649000	Washer screw spare wheel cover, Ø 15x8,5x1,6 mm, for Vespa PX/T5/Cosa/Rally/TS handle bar lever brake/choke for Vespa PKXL FL/HP/N/XL2 /Automatica, starter for LML Star 125-200 2T/4T/Deluxe 2T/4S/Speedy /Stella	0,95 EUR
60		70904700	Washer brake caliper SKR, M8x15 mm, (th) 1,0mm, for Vespa PX `98/MY also for cover brake master cylinder	0,50 EUR
61		27159600	Screw M8x25 mm, inner hexagonal, cilinder head, AF 6mm, steel, zinc plated, 8.8, brake caliper, for Vespa ET 2/ET 4/LT/LX/LXV /PX/S/Primavera/Sprint/GTS /GTS Super/GTV/946 50 /300ccm, brake master cylinder for Vespa PX `98/MY	1,00 EUR
62		90240000	Sealing Ring (th) 1,5mm, hyd.. ..raulic aluminium, Ø 10,2x15 mm	0,60 EUR
63		90210000	Banjo Bolt M10x1 mm, 18mm, for `98 pressure transducer	8,90 EUR
64		SP3601077	Brake Hose SPIEGLER front, for Vespa ET2/ET4 50-150ccm, transparent, l 1140 mm, 90°, 20°, with TÜV approval	85,00 EUR
64		PI563886	Brake Hose PIAGGIO front, for Vespa ET2/ET4 50-125ccm	39,00 EUR
97		99423000	Hand Book PIAGGIO/VEPSA Sfera /Typhoon/ZIP/Fly/Skipper/ HEXAGON/Liberty/NRG/B125/X8 /X9/ET2/ET4/LX/LX2/LX4/LXV/S /GT/GTS/GTV" service & repairs, German, 434 p., 1356 illustrations, 30 circuit diagrams, 2nd edition	29,90 EUR
97		98970000	Hand Book "PIAGGIO TPH/Sfera /ZIP/ NRG/SKR/Hexagon-Vespa ET2/ET4" service & repair manual, English, 150 p., many illustrations	29,00 EUR
98		14235000	Brake Cleaner SIP 500ml, spray	3,90 EUR
98		14131000	Skin Cleaner "Fast Orange", 440ml	7,90 EUR
98		14130000	Skin Cleaner LOCTITE SF 7850, 400ml	12,20 EUR

98		14080000	Multi-Purpose Grease REPSTAR 400g	5,50 EUR
98		14101000	Thread Locker Oil LOCTITE "641", medium strength, yellow, 10ml	17,20 EUR
98		14105000	Bearing/Oil Seal Sealer LOCTITE "603" high strength, green, 10ml	16,50 EUR
98		14110000	Hand Cleaner (paste) TEROSON /HENKEL 300g	6,30 EUR
98		14230000	Brake Cleaner MASTERCARE /REPSTAR 500ml, spray	3,50 EUR
98		14103000	Activator LOCTITE 7240, 90ml	24,50 EUR
98		14102000	Repair Glue Bearing Seating LOCTITE 660, 50ml	52,00 EUR
99A		20842000	Chuck SIP lower bearing shell upper steering column removal, for Vespa all models also for GILERA/PIAGGIO alle Modelle	22,00 EUR
99A		BU5419	Steering Head Bearing Wrench BUZZETTI universal for GILERA/PIAGGIO/Vespa all models	21,50 EUR
99A		21330000	Tool SIP mounting upper/lower bearing shell, frame, for Vespa all models also for GILERA/PIAGGIO 50-300ccm 2T/4T AC/LC 450 mm, 4 parts, not for PI597783	42,00 EUR
99A		BU5420	Steering Head Bearing Nut SIP universal, for GILERA/PIAGGIO/Vespa all models Grade A - perfect repair	32,00 EUR
99A		16029000	Chuck SIP lower bearing shell lower steering column removal installation, for Vespa all models also for GILERA/PIAGGIO alle Modelle	27,00 EUR
99A		20004000	Chuck SIP upper bearing shell of lower head set bearing, removal, for Vespa all models also for GILERA/PIAGGIO alle Modelle	32,00 EUR
99B		20837529	Set of Socket Spanners MINI 1/4", chrome-vanadium-steel, 160x8..2x32 mm, plastic case, 23 pieces	42,00 EUR

99B		MXMG05L	Gloves Mechanix The Original, black, unisex, size L, 60% nylon, 35% polyurethan, 5% elastane	29,90 EUR
99B		12194000	Knee Pad SIP 435x195x30 mm, foam EVA, black /red	10,20 EUR
99B		15199100	Mobile Scooter Hoist for Vespa V50/PV/ET3/PK/VNA -Rally/PX also ET2/ET4/LX/LXV /S/Primavera/Sprint/GTS/GTS Super/GTV/GT 60/GT/GT L 50 -300ccm 2T/4T universal, 360° rotatable, hight min.: 13cm, max, 43cm, net weight: 34kg, load: 400kg	185,00 EUR