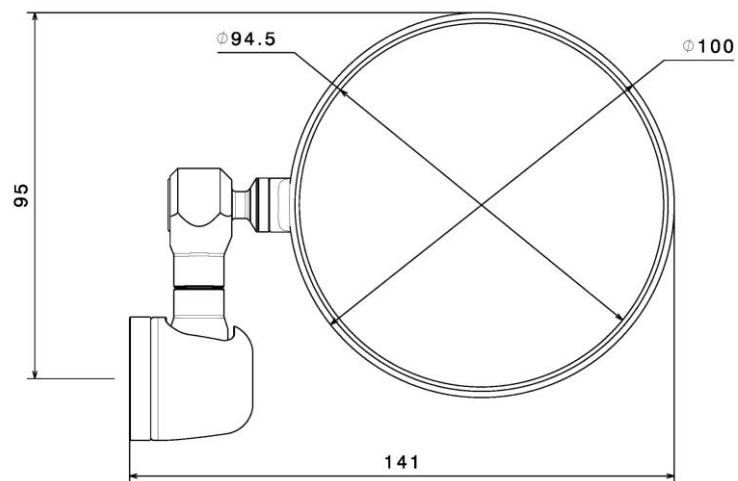

E1

000042

Issued by:	Kraftfahrt-Bundesamt Fördestraße 16, 24944 Flensburg Germany
Place & Date of type-approval:	DE-24932 Flensburg, 05.11.2014
Report No.:	14-00172-CP-BWG-00
Issued by:	TÜV SÜD AUTOMOTIVE GMBH DE-80686 München
Date of issue:	06.11.2014
Approval identification:	E1 000042

Product Codes: BS294A, BS294B**Technical Drawing:**

Marking:	Engraved by laser.
Field of application:	2 or 3 wheel motorcycles and vehicles treated as such. (PTWs, ATVs, Scooters, Motorcycles, Moped)

